



Clydesdale

(Model 8491)

Non-Catalytic,
Wood Burning
Fireplace Insert

OWNER'S MANUAL INSTALLATION & OPERATING INSTRUCTIONS



We recommend that our products be installed and serviced by professionals who are certified in the U.S. by NFI (National Fireplace Institute).

www.nficertified.org

Please read this entire owner's manual before you install and use your new Clydesdale wood burning fireplace insert. To reduce the risk of fire, follow the installation instructions. Failure to follow these instructions may result in property damage, bodily injury, or even death.

SAVE THESE INSTRUCTIONS FOR FUTURE REFERENCE!

**Contact Local Authorities Having Jurisdiction (Building Department or Fire Officials)
About Permits, Restrictions, and Installation Inspection Required in Your Area.**



Intentionally Blank

Table of Contents

INTRODUCTION	4
CODES	4
SAFETY INFORMATION	5
PERIODIC CHECKLIST	6
EMERGENCY PROCEDURES	6
SPECIFICATIONS	7
INSTALLATION	8
Unpacking	8
Packing List.....	8
Hearth Requirements & Floor Protection	9
Clearances to NFPA 211 Protected Surfaces	9
Clearance to combustibles.....	9
Installing the Insert	10
Installing the surround.....	14
Removing & Reversing the Door.....	14
Removing the Ash Lip Cover & Façade	15
Blower Power Cord Routing.....	16
VENTING COMPONENTS & CONFIGURATION	17
Installing a Venting System	17
Connecting Your Wood Fireplace Insert	17
Connecting to a Prefabricated Metal Chimney.....	17
Connection to a Masonry Chimney	18
OPERATION	21
Controls & Features	21
Operating the Blower	21
Choosing Firewood	21
Wood Heat Value: Sorted By Btu Content	22
Building a Fire	23
Breaking in Your Wood Fireplace Insert.....	23
Operating Your Insert Efficiently.....	24
Intermittent Operation	25
Building a Fire for Everyday Use.....	25
Disposal of Ashes	25
Over-Fire Caution.....	25
MAINTENANCE	26
Creosote Formation and Need for Removal.....	26
Gaskets.....	26
Glass.....	26
Cast Iron.....	27
Blower System	28
TROUBLESHOOTING	29
Basic Heating Issues.....	29
Draft Sampling Access Port	29
Troubleshooting Guide.....	30
REPLACEMENT PARTS & OPTIONAL ACCESSORIES	31
SAFETY LABEL	32

Introduction

Congratulations! You have just invested in a most unique wood burning Fireplace Insert – the Clydesdale Model 8491 is a clean burning EPA certified, non-catalytic wood burning Fireplace Insert. You can be proud to join the Hearthstone family with our *Premier* Cast Iron Wood Burning Fireplace Insert. The generous firebox depth and width allows for loading of wood up to 22 inches long!

Your purchase ensures years of clean, comfortable heat with minimal maintenance. You will receive the benefits of the most advanced technology in wood burning without the cost and maintenance requirements of a catalytic Fireplace Insert. The Clydesdale blends modern technology with the unique beauty and heating qualities of soapstone (used as the firebox lining) and cast iron. Soapstone is well known for its even heat production and long heat-retaining ability. We trust that you will appreciate the quality of our handcrafted product.

Please read this manual in its entirety. Its purpose is to familiarize you with your Fireplace Insert's safe installation, proper break-in, operation and maintenance. It contains information that is useful to you now, and in the years to come. So keep it handy and refer to it as needed.

Use these instructions as well as national, state, and local building codes to install your Fireplace Insert. Ensure to maintain the designated stovepipe and Fireplace Insert clearances to walls, ceilings, hearth, and other combustible surfaces. This will help

reduce the risk of fire. Failure to follow these instructions can result in property damage, bodily injury, and even death.

Keep furniture, drapes, curtains, wood, paper, and other combustibles far away from the Fireplace Insert. Never install the Fireplace Insert in a location where gasoline, kerosene, charcoal lighter fluid or other flammable liquids are used or stored.

SAFETY NOTICE:

A HOUSE FIRE MAY RESULT IF THIS FIREPLACE INSERT IS NOT INSTALLED PROPERLY. FOR YOUR SAFETY, CAREFULLY FOLLOW THE INSTALLATION INSTRUCTIONS. CONTACT LOCAL BUILDING OR FIRE OFFICIALS ABOUT RESTRICTIONS AND INSTALLATION INSPECTION IN YOUR AREA.

The performance of your Fireplace Insert depends on many variables. Since all installations are unique, the general information and operating procedures presented here can only serve as useful guidelines rather than hard and fast rules. Should you have any questions, do not hesitate to contact your dealer for additional information.

This Fireplace Insert is manufactured and warranted by:

Hearthstone Quality Home Heating Products, Inc®
317 Stafford Ave.
Morrisville, VT. 05661
www.hearthstonestoves.com

Codes

When you install your Clydesdale wood Fireplace Insert, it is imperative that you adhere to all local codes, which can be obtained from either of the following two National sources:

American National Standards Institute, Inc.
(ANSI)
1430 Broadway
New York, NY 10018
www.ansi.org

National Fire Protection Association, Inc.
(NFPA)
Battery March Park
Quincy, MA 02269
<http://www.nfpa.org>

Safety Information

Read and understand this Owner's Manual thoroughly before installing and using this Fireplace Insert.

Make sure to install your Fireplace Insert:

- 🔥 According to the manufacturer's recommendations.
- 🔥 In accordance with all applicable codes.
- 🔥 With the proper sized chimney.

When using your Fireplace Insert:

- 🔥 Warn children and others unfamiliar with woodstoves of the danger of touching hot, radiating surfaces of your Fireplace Insert. For your additional safety, obtain hearth and stove guards through your local dealer.
- 🔥 Follow recommended break-in procedure as outlined in this manual.
- 🔥 Burn natural wood only. Higher efficiencies and lower emissions result when burning air-dried, seasoned wood, as compared to green or freshly cut wood.
- 🔥 Use caution when loading firewood into a hot stove.
- 🔥 Inspect the stovepipe, chimney connector and chimney, as recommended.

Follow these safety precautions:

- 🔥 **Never** modify this Fireplace Insert in any way, especially the primary air control system.
- 🔥 **Never** burn kiln dried wood, painted or treated wood, solvents, trash, plywood, colored or glossy paper, plastic, artificial logs, cardboard, coal, or driftwood. **Especially, do not burn coal in this Fireplace Insert.**
- 🔥 **Never** use gasoline type fuel, kerosene, charcoal lighter fluid, or other liquid fuels or solid

fire starters to start or invigorate the fire. These fuels can possibly generate carbon monoxide, which can sap the supply of oxygen. Keep all such materials away from the Fireplace Insert.

- 🔥 **Never** use a log grate or other device to elevate the fire.
- 🔥 **Do Not** allow logs to rest against or otherwise come in contact with the glass when the door is closed.
- 🔥 **Do Not** slam the door or use the door to force wood in to the Fireplace Insert.
- 🔥 **Never** over-fire your Fireplace Insert
- 🔥 **Never** put articles of clothing or candles on a hot Fireplace Insert.
- 🔥 **Do Not** connect the Fireplace Insert to a flue that is serving another appliance.

Other safety guidelines

- 🔥 As a general rule, keep all combustible items such as furniture, drapes, clothing, and other items, at least 36" (0.92 m) from the Fireplace Insert
- 🔥 Install a smoke detector, preferably in an area away from your wood Fireplace Insert.
- 🔥 Install a CO detector as a rule. Wood burning appliances can generate little CO, but oil and gas burning appliances can produce huge amounts if not operating properly.
- 🔥 Keep a fire extinguisher handy. We recommend the type rated "A B C."
- 🔥 Dispose of ashes properly.
- 🔥 Keep children and pets away from the stove; they could be burned by touching a hot stove.
- 🔥 Clean your chimney system as needed.

Periodic Checklist

Perform each of these tasks at the specified intervals.

At the End of Every Week:

- 🔥 Empty ashes from the firebox (sooner if the firebox begins to fill up).

At the Beginning of Every Other Month:

- 🔥 A visual inspection of the flue liner or chimney for creosote is recommended depending upon your use of the stove.
- 🔥 Check door seals using the "dollar bill test." - When the fire is out and the insert is cool, shut the door on a dollar bill. If the bill pulls out without any resistance, then your insert's door isn't sealed properly. To tighten the seal, adjust the latch spring tension or change the door gasket if necessary.

At the End of Every Season:

- 🔥 Clean any chimney connector thoroughly. Replace any pieces that show signs of rust or deterioration.
- 🔥 Inspect and, if necessary, clean your chimney (flue liner).
- 🔥 Thoroughly clean out the firebox of the Fireplace Insert.
- 🔥 Inspect all door gasket material and replace if worn, frayed, cracked or extremely hard.
- 🔥 Replace any badly cracked refractory soapstone in the firebox.
- 🔥 Clean dust away from the ash lip assembly and grills.
- 🔥 Remove the Ash Lip Cover and inspect the blower assembly - clean if necessary.

Emergency Procedures

If you have a stovepipe or chimney fire, follow these instructions:

1. If the fire is too threatening, leave the area and call the fire department immediately! If not, perform the next two steps.
2. Close the primary air control.
3. Keep the Fireplace Insert door closed!

- 🔥 **WARNING: DO NOT ATTEMPT TO PUT OUT A STOVEPIPE OR CHIMNEY FIRE BY THROWING WATER ONTO THE STOVE, STOVEPIPE, OR CHIMNEY. THE EXTREMELY HIGH TEMPERATURE ASSOCIATED WITH SUCH FIRES CAN CAUSE INSTANTANEOUS STEAM AND SERIOUS BODILY HARM.**

Once the chimney fire has expired, leave the primary air control closed and let the fire in the Fireplace Insert die out completely. DO NOT burn the Fireplace Insert again until the Fireplace Insert, connector pipe, liner, and chimney are all thoroughly inspected for any sign of damage. You must correct any damage before using your Fireplace Insert again.

To remove the Clydesdale for inspection purposes, disconnect the venting from inside the firebox. Carefully remove the surround from the insert, and slide the insert away from the fireplace.

Specifications

Maximum Heat Output: 60,000 BTU per hour of cordwood (based on independent laboratory test results).

Size of Heated Area: Up to 2,000 square feet.

Firebox Capacity: 2.4 cubic feet or 48 pounds of wood (The amount and weight of wood contained per cubic foot of firebox volume can vary from 15 to 36 lbs. per cubic foot depending on type of wood, moisture content, packing density and other factors. As a constant for comparison and test purposes, we are assuming 20 lbs. of seasoned hardwood per cubic foot of firebox volume).

Maximum Log Length: 22" (55.88 cm)

Height: 23.12" (58.72 cm)

Width: 31.62" (80.31 cm)

Depth: 24.63" (62.56 cm)

Front Door Size: 22" wide x 11.5" high (55.88 x 29.21 cm)

Stovepipe Size: 6" (152 mm) diameter

Metal Chimney: 6" (152 mm) inside diameter

Masonry Chimney: 6" (15.2cm) inside diameter (round flue)
8" x 8" (20 x 20cm) (square flue)

Flue Exit: Top exit only

Actual Weight: 550 pounds

Castings Finish: Painted Matte; and Porcelain Enamel

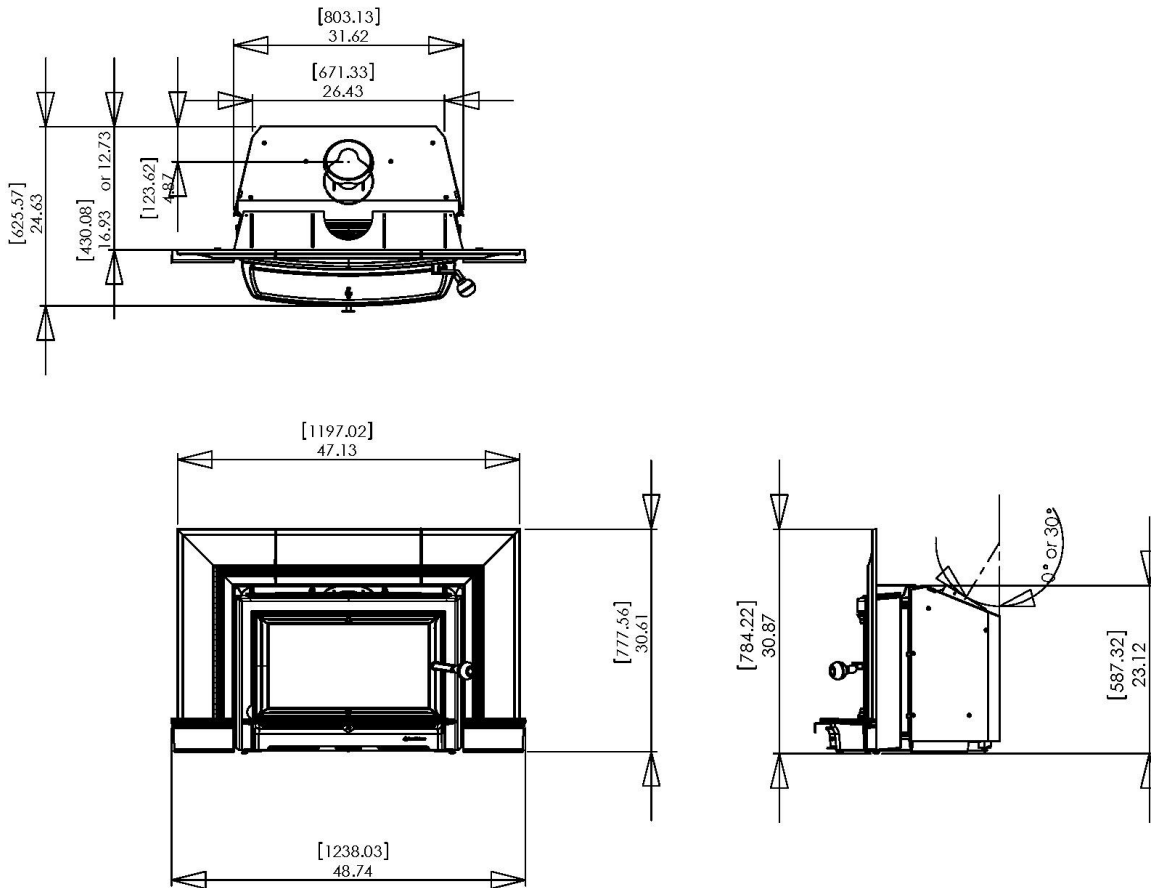

Figure 1 – Clydesdale Dimensions

Installation

Unpacking

Hearthstone packages your Clydesdale Fireplace Insert with the greatest care so that it ships safely. Under certain circumstances, however, damage can still occur during transit and handling. When you receive your Fireplace Insert, unpack it carefully, inspecting it, and all parts for damage. Also, ensure that all parts are included. If any parts are damaged or missing, please contact your dealer immediately.

Packing List

- 1- Clydesdale 8491 Fireplace Insert
- 1- Façade and Ash Lip w/ blower (in place on insert)
- 1- Façade Top Grill (in place on insert)
- 1- Surround Kit Box (ships on top of insert)

In Firebox:

- 1- Box, Refractory Stone Kit
- 1- Bag, Door Handle Kit
- 1- Envelope, Owner's Manual Packet
- 1- Pouch, Touch-up Paint (Enamel only)

Pre-Installation Prep

When installing this unit in a fireplace, you must attach the provided metal label (3300-625) to the

fireplace prior to installing the insert (see illustration on page 18).

WITH ALL CHIMNEYS, A POSITIVE CONNECTION MUST BE MADE BETWEEN THE FIREPLACE INSERT'S FLUE COLLAR AND THE CHIMNEY (see page 17).

Ensure that the Fireplace Insert will have enough clearance to combustible materials in the vicinity. These combustibles can include walls, floor, ceiling, fireplace mantle, and chimney decor. You must carefully consider the clearances to all of these combustibles before actually connecting your Fireplace Insert.

Read this chapter to obtain a sound understanding of how to properly install your Fireplace Insert. Contact the following agency for more information:

National Fire Protection Agency

Batterymarch Park
Quincy, MA 02269
1-800-344-3555
1-617-770-3000
www.nfpa.org

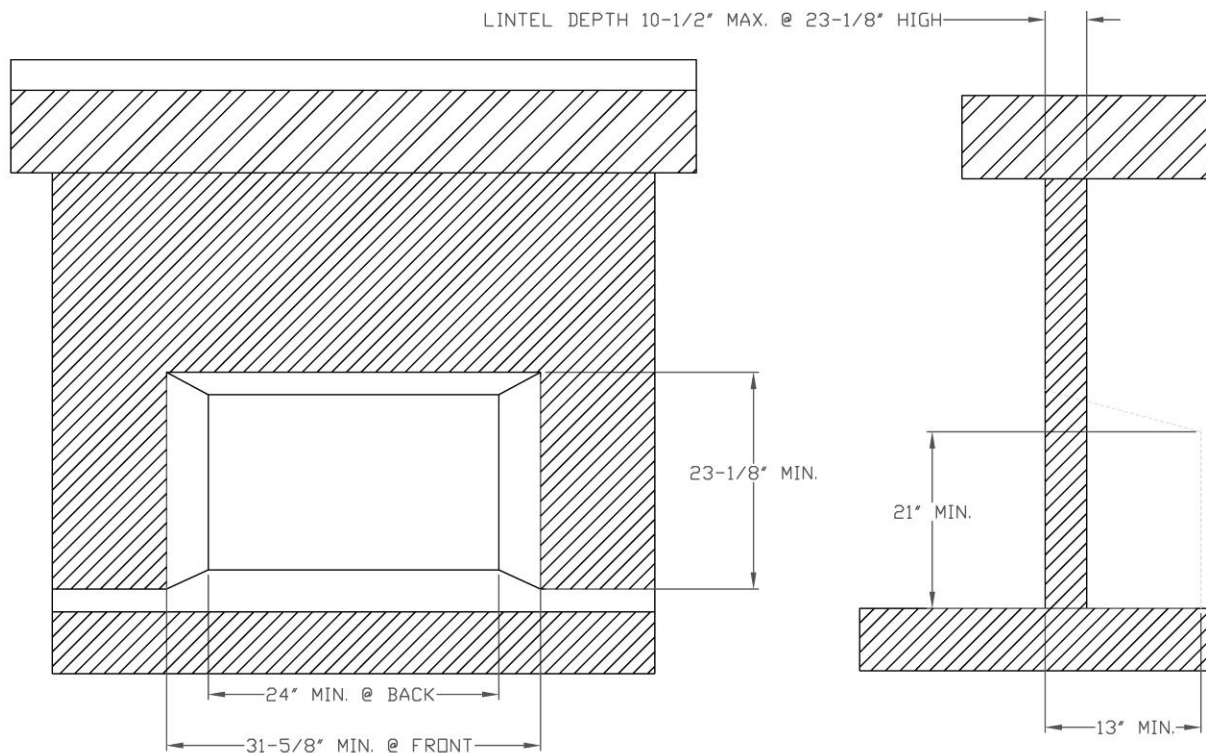

Figure 2 – Minimum Fireplace Dimensions

Hearth Requirements & Floor Protection

Combustible flooring must be protected with a covering of noncombustible material (slate, marble tiles, other noncombustible material can be used for this purpose). The floor protection must extend beyond the body of the Fireplace Insert at the minimum as follows and have a minimum "R-Value" of 1.0.

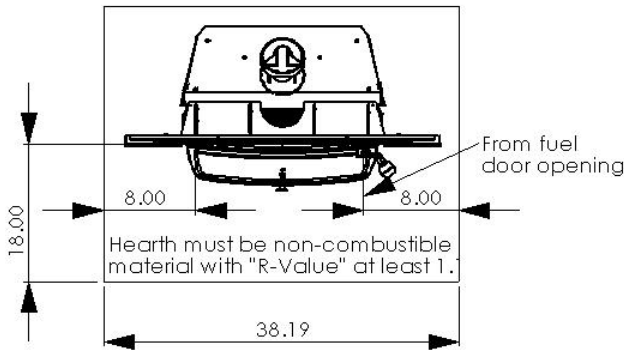

Figure 3 – Hearth Requirements

Noncombustible Material	Thickness	R-value
Gypsum or plaster board ¹	1/2"	0.45
Wallboard, Wonderboard, or Durock ¹	1/2"	0.20
Ceramic board (Fiberfrax or Micor) ¹	1/2"	1.10
Nominal solid clay brick ¹	1"	0.20
Ceramic wall or floor tile ¹	1/4"	0.01
Mineral wool insulation ²	1"	3.12
Cement mortar ²	1"	0.20
Horizontal still air ² *	1/8"	0.92

Floor protectors come with various types of specifications. To convert a floor protector's specification to an R-value, do one of the following:

1. If the R-value is given, use that value - no conversion is needed.
2. If a K-factor is given with a required thickness (T) in inches, use this formula: R-value = 1/K x T
3. If a C-factor is given, use the formula: R-value = 1/C

To determine the R-value of the proposed alternate floor protector:

¹ Check manufacturer's specifications

² According to ASHRAE Handbook of Fundamentals 1977

1. Use either the K-factor or the C-factor formula explained above to convert specifications not expressed as R-values.
2. For multiple layers of floor protectors, simply add the R-values of each layer to determine the overall R-value of the layers.

If the overall R-value of your setup is greater than the R-value of the specified floor protector, then your setup is acceptable.

Clearances to NFPA 211 Protected Surfaces

You can reduce the clearances to combustible surfaces by using any National Fire Protection Agency (NFPA) approved wall protection system. Refer to NFPA 211 for specific and complete details:

National Fire Protection Agency

Battery March Park
 Quincy, MA 02269
 1-800-344-3555
 1-617-770-3000
www.nfpa.org

Clearance to combustibles

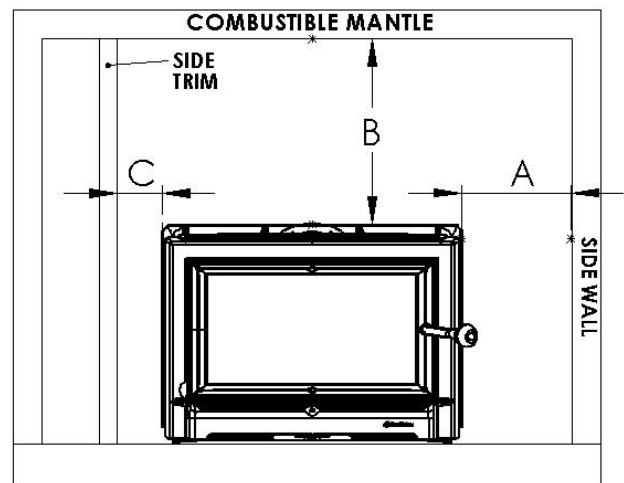

Figure 4 – clearances to combustibles

- A- Side wall = 12"
- B- Mantle and top trim = 27" *
- B- Mantle/ with mantle shield kit = 11" *
- C- Trim = 9"

* Measured from top of sheet metal shroud

Installing the Insert

Step One: Remove the contents of the firebox. This will include the owner's manual packet, a box of soapstone refractory bricks, the handle knob assembly, and a pouch containing enamel touch-up (if applicable).

Step Two: Remove the Clydesdale from the pallet (see Photo 1).

Locate the three mounting clips attached to the leveling bolts (two in the front and one in the back) that secure the insert to the shipping pallet.

1. Using a 1/2" wrench, remove the rear lag screw and mounting clip.
2. Check the front clips – if there is sufficient clearance above the lag screws to clear the façade, remove them.
3. Otherwise, if the lag screw is close to and under the façade (see photo 1), carefully loosen the front clip lag screws about one turn. Take care to not damage the finish on the façade.
4. Slide the insert backwards about one inch to disengage the front clips.
5. Once all the clips are disengaged, turn the rear leveling bolt upward (tighten) to ease insert installation into the fireplace.

The Insert ships with the Façade and ash lip cover installed. You should not need to remove these in a typical installation.

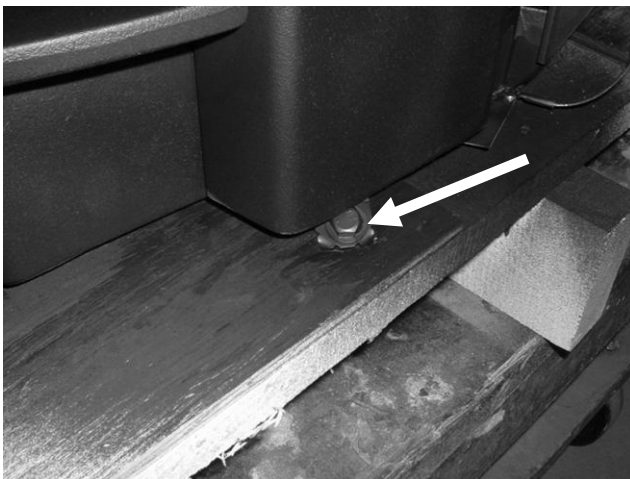

Photo 1 – Pallet Mounting Clip Detail (Right Front Shown - Façade Installed)

Step Three: Install the wooden knob onto the latch handle. The knob, and bolt are located in a plastic bag removed from the firebox in step one. Push the

bolt through the knob. Turn the bolt onto the latch handle and tighten with a hex wrench. Handle is shown installed correctly in photo 2.



Photo 2 – Door Handle & Latch Detail

Step Four: Measure the opening of the fireplace. When measuring the fireplace cavity, you will need to determine the following:

1. Will the flue collar be installed in the forward or aft position? The depth of the firebox will determine the location of the flue collar. **NOTE:** the collar is installed at the factory in the aft position to accommodate the most common type of install that requires use of an elbow or flex connector for attachment to the chimney liner. To change the collar to the forward position for a shallow fireplace, follow the instructions in step five. Proceed to the next step if the aft position is correct for your installation.
2. **Note:** With the collar is in the aft position - to properly attach the liner or connector to the flue collar using all three screws, you must remove the baffle/plenum and drop the flue collar into the firebox for attachment of the flue liner. If the baffle/plenum and flue collar do not need to be removed, you can skip to step 7.

Step Five: Change the position of the flue collar if necessary. To remove the flue collar, reach in through the flue collar and locate the four bolts threaded down through the insert top on the corners of the flue collar. Remove the nuts with a 7/16" wrench. Lower, and turn the collar 180 degrees to the forward position. Fit the four holes on the collar over the four bolts. Fasten the nuts back onto the bolts and tighten them with the 7/16" wrench. Now

place the insert into the fireplace opening and connect to the flue liner (meeting UL 1777).

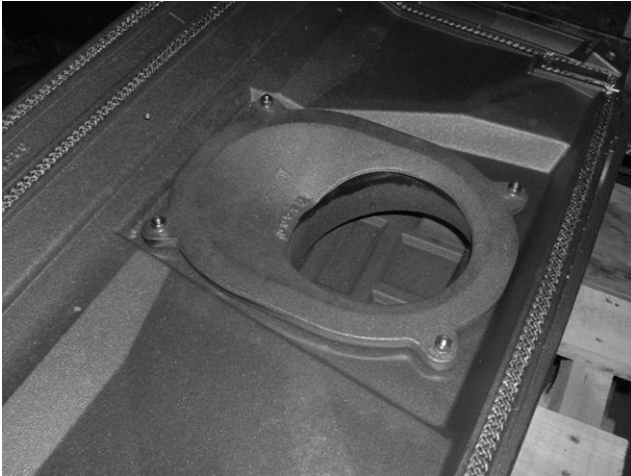

Photo 3 – Collar Mounting Detail (Inside Firebox)

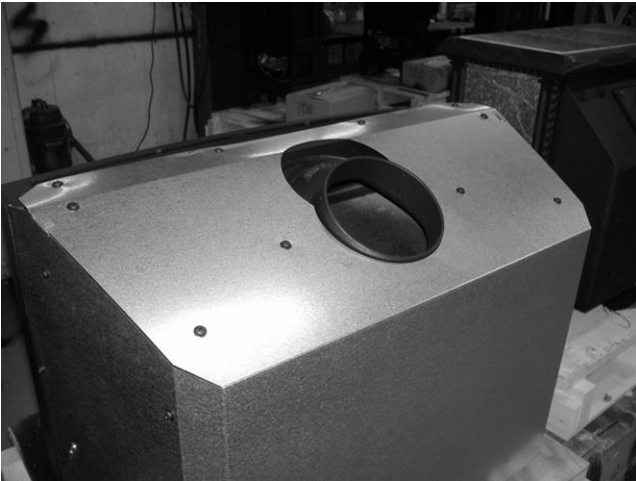

Photo 4 – Air Shroud Installed (default)



Photo 5 - Collar in Default 30° Aft Position (air shroud removed for clarity)

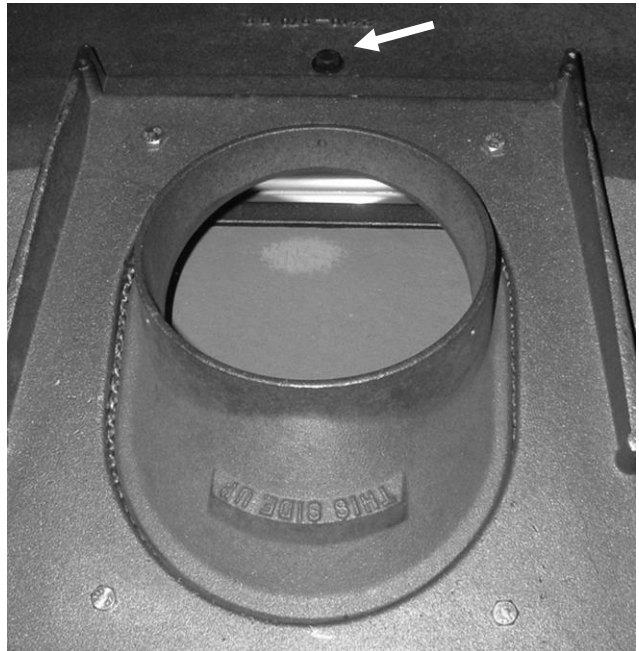

Photo 6 – Collar in Forward (90° Position)

NOTE: In order to connect the liner to the flue collar properly with three screws when the flue collar is in the aft (default) position, you must remove the baffle/plenum and drop the collar into the firebox. Removing the baffle will also allow you to connect the flue liner to the flue collar in the forward position if space above the insert installed in the fireplace is limited.

Step Six: Remove the baffle/plenum.

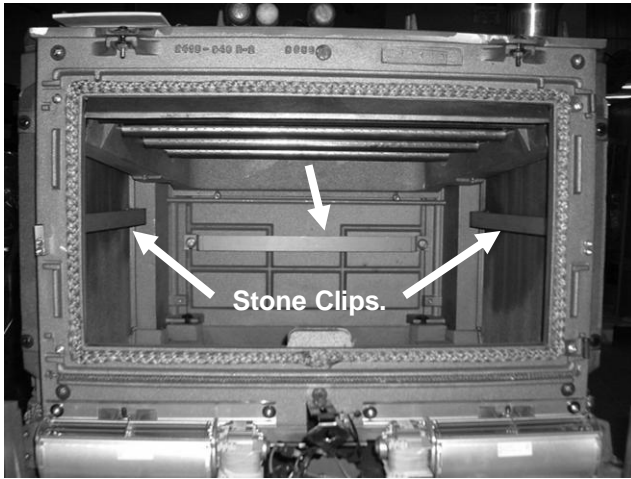

Photo 7 – Stone Clip Detail

🔥 **NOTE:** Before the baffle can be removed, the 3 stone retaining clips (one in the rear and one on each side) must be removed from the firebox. Remove the clips by removing the fasteners that hold them to the firebox.

1. To remove the baffle / secondary air plenum, loosen the two socket head machine screws that hold it in place with a 5/32" hex wrench (see photo below). Once these screws are loose, lift the baffle assembly off the screws and maneuver it carefully out of the firebox.

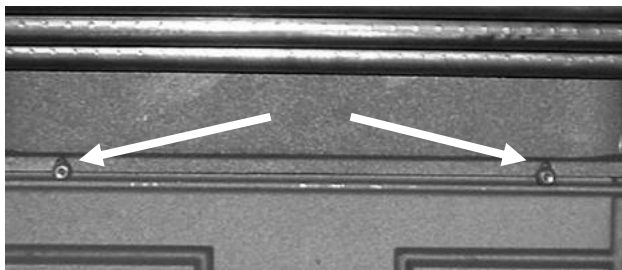

Photo 8 – Plenum Fastener Detail

The removable plenum/baffle assembly inside the Clydesdale firebox. (Shown looking straight into the firebox.)

🔥 **NOTE:** If access to the top of the insert is restricted when installed, you will want to loosely attach the mounting bracket for the surround now. For installation details see the instructions provided with the surround.

2. With the baffle/plenum out of the firebox, remove the flue collar as described in step five. Place the flue collar in the firebox and insert the Clydesdale

into the fireplace opening. Drop the flue liner (meeting UL 1777) into the firebox through the flue collar opening. Attach the flue liner, or connector to the collar, push the collar and flue liner up to the top of the firebox, ensure the collar slips onto the four bolts, and secure it by turning the nuts back onto the bolts and tighten with a 7/16" wrench.

Place the baffle / secondary air assembly back into the firebox and re-install.

🔥 **CAUTION: THE BAFFLE MATERIAL IS A HIGH TEMPERATURE CERAMIC. IT WILL LAST FOR MANY YEARS UNDER NORMAL USE; HOWEVER, IT IS EASILY DAMAGED BY IMPACT OR FORCE. APPLY PRESSURE TO THE STAINLESS STEEL AIR TUBES AND CAST IRON ONLY!**

- a. Place the baffle inside the stove with the ceramic board facing up, and the stainless steel shelf tabs forward.
- b. Lift the baffle and slide the rear baffle sleeves fully into the slots on the rear of the unit. The slots on the baffle will drop back onto the threaded rods in the back of the firebox
- c. Gently lower the front of the baffle until the shelf tabs are resting on the sidewall.
- d. To verify that the baffle is in the correct position, gently tug down on the front of the baffle. If it does not move – placement is correct. Tighten the machine screws loosened in step one.

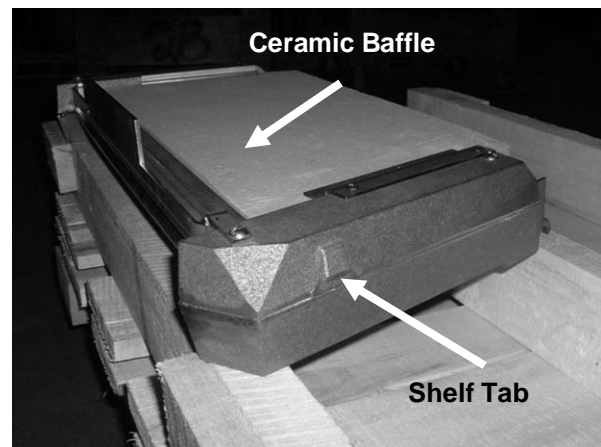

Photo 9 – Baffle/Plenum Shelf Tab Detail

Step Seven: With the unit in the desired position within the fireplace, level the unit using a box end wrench on the square portion of the left and right leveling bolts (if façade is installed). Use a 9/16" socket wrench on the Stover nut to adjust the rear leveling bolt (see photos 10 through 12).

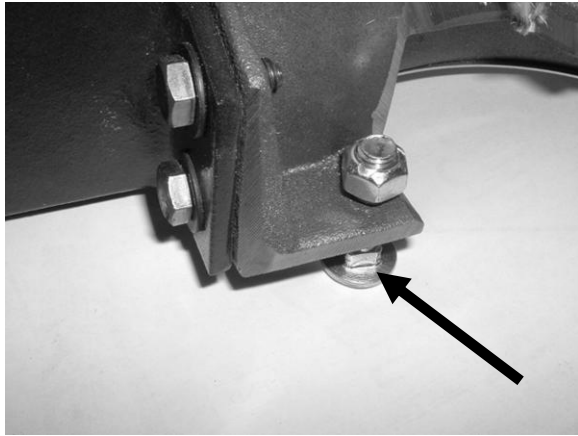

Photo 10 – Leveling Bolt Detail (Right Front Shown with Façade removed & Stover lock nut installed)

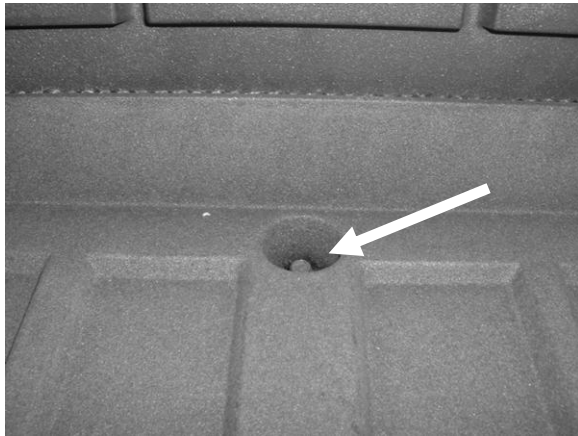

Photo 11 – Rear Leveling Bolt Detail (With Stover lock nut installed - accessed in Firebox)

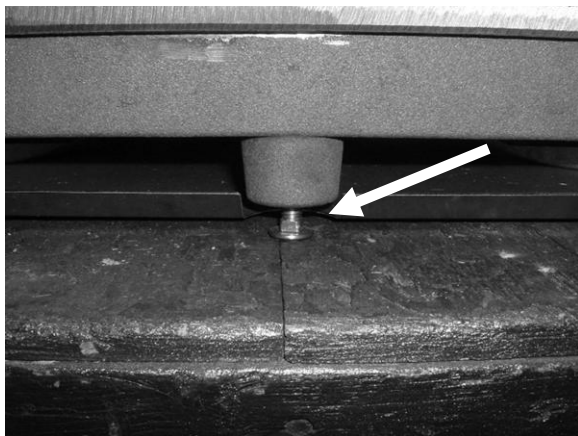

Photo 12 – Rear Leveling Bolt (Rear View)

Step Eight: Install the soapstone refractory pieces in the firebox (see photos 13 through 15).

The Clydesdale refractory stone set includes the following stones:

- 9 ea: 4-1/2" x 9" (A)
- 1 ea: 4-1/2" X 4-1/2" (B)
- 2 ea: 4-1/2" X 12" Angled Cut (C)
- 2 ea: 4-1/2" x 11-1/4" Angled Cut (D)

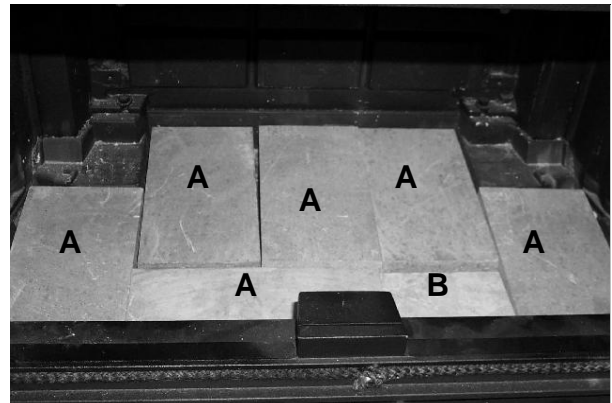

Photo 13 – Firebox Floor Stones

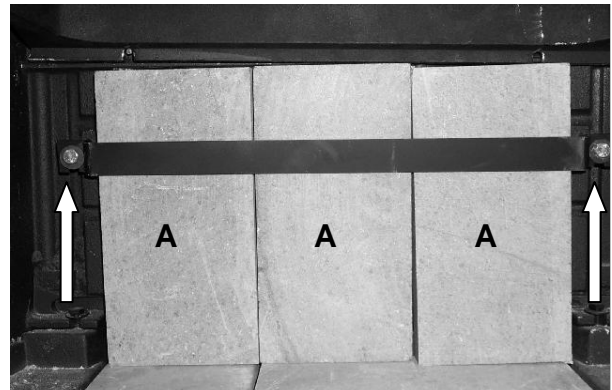

Photo 14 – Install & Secure Firebox Rear Stones

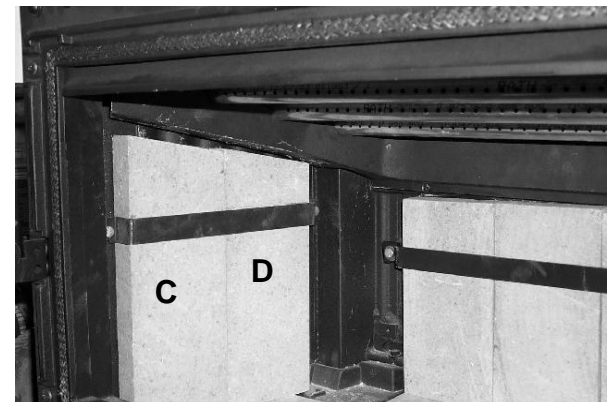

Photo 15 – Left and Right Side Stones

Installing the surround

Step Nine: Remove the surround components from the large cardboard box that accompanied the Clydesdale Insert. Included are the surround panels, assembly hardware, and surround mounting bracket. Refer to the instructions included with the surround for complete assembly and installation.

Read this **Owner's Manual** for all other installation and operational requirements.

Removing & Reversing the Door

To reverse the door to open from the right, first cover the ash lip cover with cardboard or a towel (to avoid scratching it), then remove the door.

1. Open and support the door, then remove the machine screw securing the upper inner hinge. Lift the door off the lower, inner hinge section.

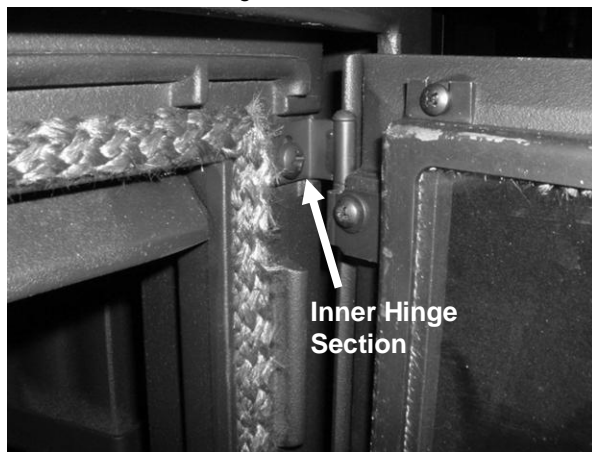

Photo 16 – Upper Hinge Mounting Detail

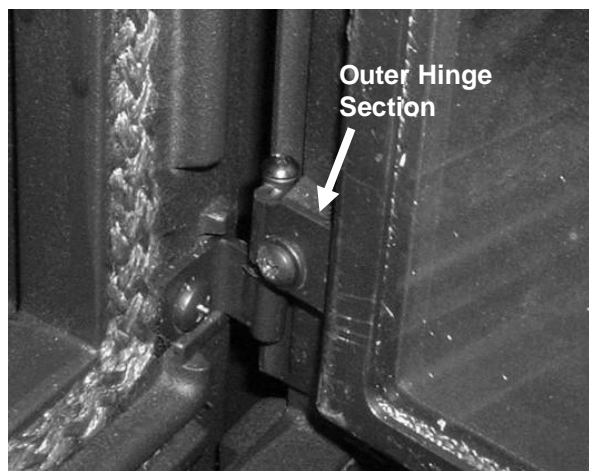

Photo 17 – Lower Hinge Mounting Detail

2. Remove the lower hinge section from the insert.

3. Remove, and set aside the two hinge pins and any spacer washers.

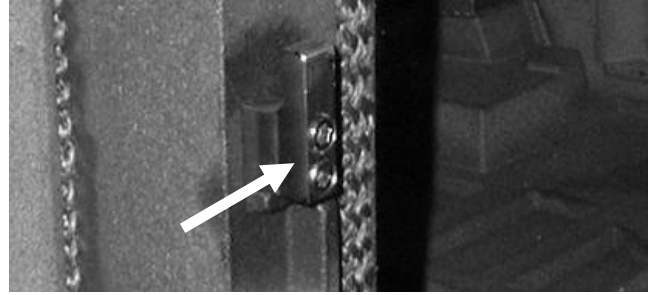

Photo 18 - Reversible Door Catch

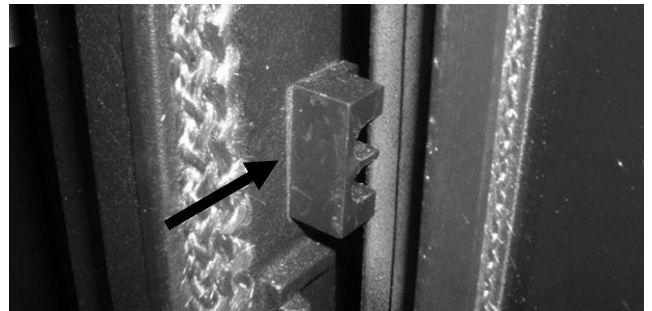

Photo 19 – Reversible Door Stop

4. Use a hex wrench to remove the door catch and the screws (and the door stop if present) on the right side.
5. Reattach the door catch on the opposite side of the front, using the same screws. Reattach the screws (and door stop if present) on the left where the catch was.
6. Remove the two Phillips head screws where the hinges will go on the left side – install them on the right side.
7. Rotate both inner hinge sections 180 degrees and mount the lower hinge's inner section on the left side of the insert.
8. Rotate the door 180 degrees – you do not have to remove or adjust the handle.
9. Insert the pin in the lower hinge's outer section.
10. Insert the hinge pin in the upper hinge's inner section and place it on the upper outer hinge section still attached to the door, reinstall any spacers.
11. Position the door so it is open about 80 degrees and place it on the lower inner hinge section.
12. Attach the upper inner hinge section to the insert.
13. Tap the pins down to seat them if necessary.
14. Close the door and check its alignment – ensure it is square in the opening, and that it does not drag on the ash lip cover. Adjust the hinges/spacers if needed.
15. Check the gasket seal using the dollar bill test. Close the door on a dollar bill – if the bill pulls out without any resistance at any point; this is where it will leak, adjust the door accordingly.

Removing the Ash Lip Cover & Façade

In some instances, it may become necessary to remove the Façade or Ash Lip Cover. To remove the Façade, you must first remove the Ash Lip Cover. To service the blower, you must also remove the Ash Lip Cover.

1. To remove the Ash Lip Cover, loosen the two hex socket head set screws securing the ash lip cover as shown in photo 20. In order to lift the ash lip cover, you must loosen the set screws enough to clear the mounting clips (see photo 21).

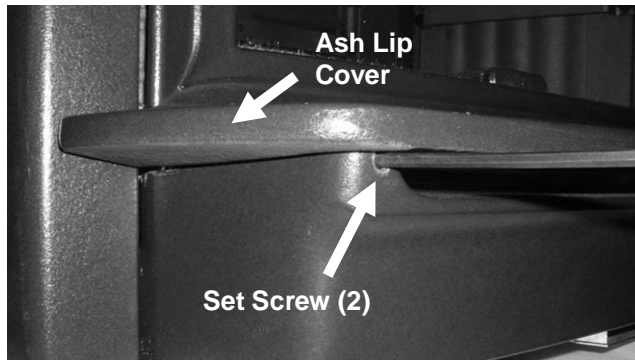

Photo 20 – Ash Lip Cover Detail

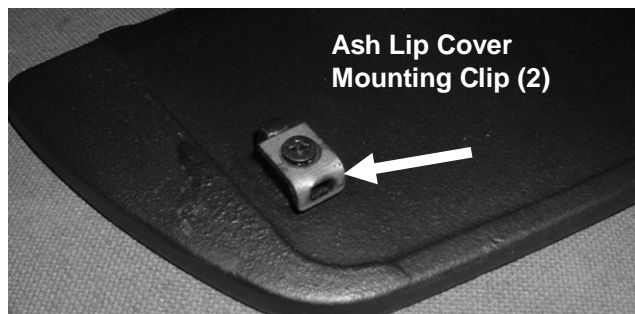

Photo 21 – Ash Lip Cover Mounting Clip Detail

2. To remove the Façade, first remove the top grill (see photo 22). On brown enamel Clydesdales, carefully lift the grill straight up to avoid scratching or chipping the façade's finish.

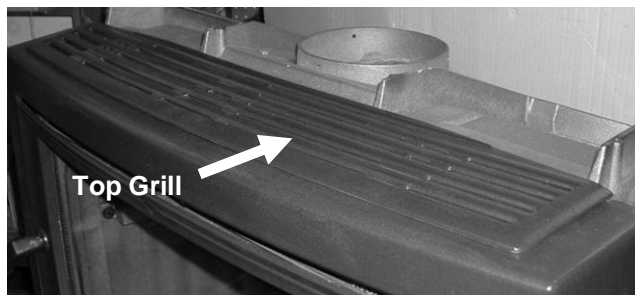

Photo 22 – Top Grill

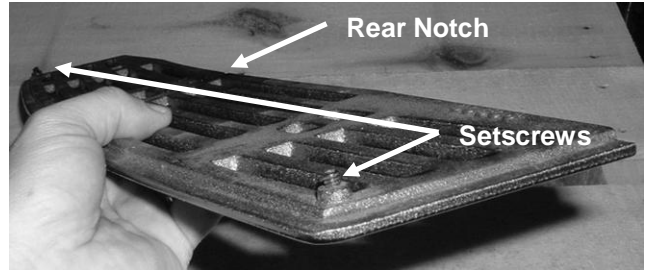

Photo 23 – Top Grill Adjustment Point Detail

3. The Top Grill on brown enamel finish Clydesdales uses three adjustment points to keep the grill from resting on the façade's enamel surface. The draft port plug (see photo 32), and two setscrews (see photo above) are adjusted at the factory, but may need further adjustment after installation or maintenance.
4. Lift the Façade up slightly and tilt it towards you so the mounting clips clear the lip on the stove body (see photo 24). Carefully move the Façade away from the insert and set aside.

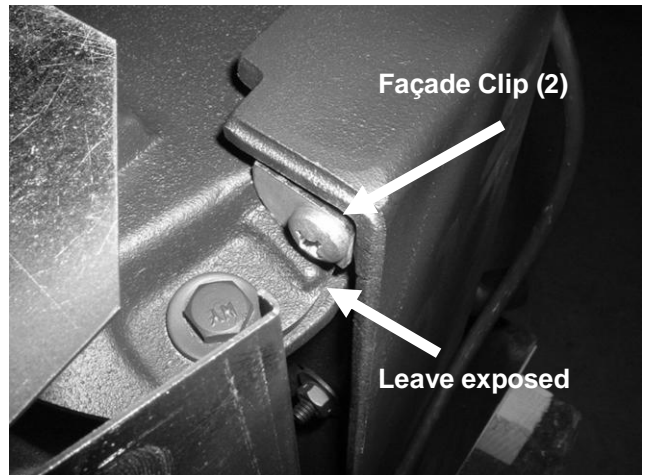

Photo 24 – Façade Clip Detail (rear view)

5. When ready, reinstall the Façade, Top Grill, and Ash Lip Cover.

Note: The façade is correctly mounted when the clips are positioned as shown in photo 24. Do not remount the façade and place the mounting clip behind the second inner cast lip shown above.

Blower Power Cord Routing

The Clydesdale 8491 ships from the factory with the blower system's power cord routed on the left side of the insert as you face it. If your installation requires the cord on the right side, you must remove the façade and disassemble the ash lip assembly to access the wire clips to change the position of the power cord.

1. Loosen Set Screw and remove Ash Lip Cover. Remove the Façade as described on page 15.

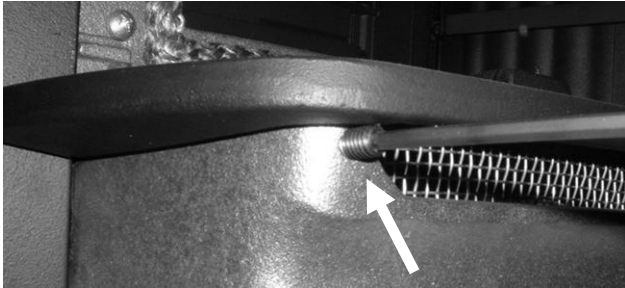

Photo 25 – Set Screw Detail

2. Remove screw and step bushing securing the air control to the bracket.



Photo 26 – Air Control Mounting Detail

3. Use a 1/2" socket, or wrench and remove the 4 bolts and washers securing the Ash Lip Assembly to the body of the insert. There is no need to disconnect any wires.

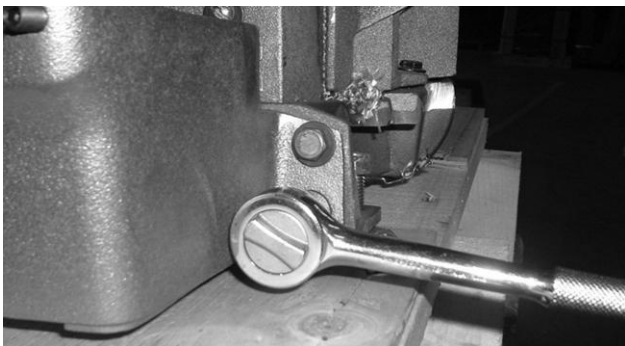

Photo 27 – Ash Lip Assembly Fastener Detail

4. Use a Phillips head screwdriver to remove the screws securing the wire loops on the left and transfer everything to the right side ensuring you place the loops in the equivalent locations (arrows). A wire loop must be placed on the screw closest to the corner to ensure the cord does not rub on the blower housing. Do not disconnect any wiring – there is more than sufficient length to route the cord to the right over the top of the blower speed control.

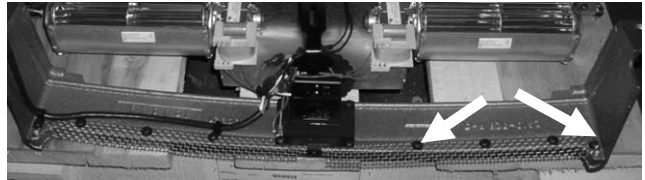

Photo 28 – Wire Loop Mounting Detail

5. Re-attach the ash lip assembly to the front of the insert. Ensure the cord is not touching the blower housing and is routed through the space above the mounting flange. Ensure the cord is not pinched in any way. Re-attach the screw and step bushing securing the air control to the bracket. Ensure the air control moves freely. Re-install the façade and then the ash lip cover.

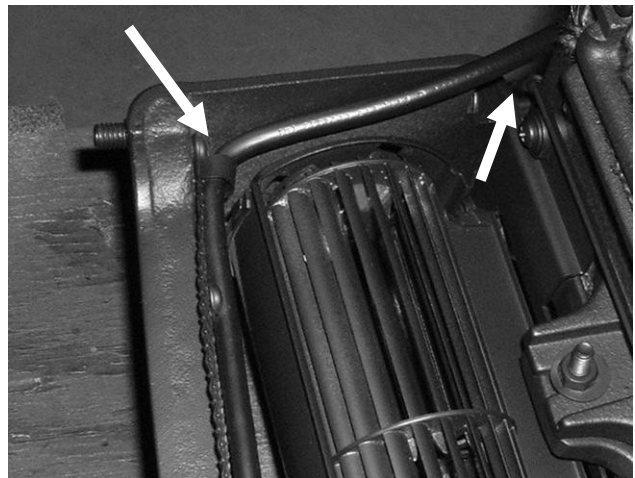

Photo 29 – Correctly Routed Cord Detail

Venting Components & Configuration

Installing a Venting System

🔥 **DO NOT CONNECT THIS UNIT TO ANY AIR DISTRIBUTION DUCT OR SYSTEM**

Secure all joints, including attaching the flue liner to the Fireplace Insert's flue collar, with three sheet metal screws. Install #10 x 1/2" (3 mm x 13 mm) sheet metal screws into the holes pre-drilled in the flue collar. Eliminating the screws can cause joints to separate from the vibrations that result from a creosote chimney fire.

Remember, the NFPA has recommended minimum clearances for chimney connectors to combustibles such as walls and ceilings. Once the Fireplace Insert is installed at safe distances from these combustible surfaces, it is important to maintain these connector clearances for the remainder of the installation.

Connecting Your Wood Fireplace Insert

You can connect your Clydesdale to a prefabricated metal chimney or a masonry chimney. See *Figure 5* for an example to aid in connections.

🔥 **With all chimneys, a positive connection must be made between the fireplace insert's flue collar and the chimney.**

In an existing Masonry Chimney, use one of the approved following methods:

In the U.S:

1. Connect the insert to a listed 6" stainless steel flexible connector that connects to a listed 6" stainless steel liner extending the full length of the chimney.
 - A 22 ga. or greater Blue Steel 6" connector is also acceptable to attach to the flue liner.
2. Connect the insert to a listed 6" stainless steel flexible connector that extends beyond the fireplace's damper into an approved flue tile liner.
3. In all cases, a sealed block off plate, or a plug of other noncombustible material such as unfaced fiberglass insulation, must be installed at the damper area of the existing fireplace to seal the chimney from the room air.

In Canada:

4. The fireplace insert must be installed with a continuous chimney liner with a minimum diameter of 6" extending from the fireplace insert to the top of the chimney. The chimney liner must conform to the class 3 requirements of chimney liner standards can/ulc-s635 or can/ulc-s640.

🔥 **Do not use aluminum or galvanized steel pipe as a connector or chimney liner. These materials are not suitable for solid fuel burning applications.**

Connecting to a Prefabricated Metal Chimney

You can install the Clydesdale in masonry or zero clearance fireplaces. Before installing the stove in a factory-built fireplace, the fireplace must have the following characteristics:

- 1) Listed per UL 127 or ULC S610.
- 2) Include a full height listed chimney liner meeting type HT requirements (2100° Fahrenheit) per UL 1777 (United States) or ULC S635 (Canada) standards.
- 3) The means to prevent room air passage to the chimney cavity of the fireplace.
- 4) Does not disturb the airflow in or within the fireplace when installed (louvers, or cooling air inlet or outlet ports must not be blocked).
- 5) Not be altered in any way, except for the following:
 - a) External trim pieces which do not affect the operation of the fireplace can be removed, providing they are stored on or within the fireplace for re-assembly if the insert is removed.
 - b) The chimney damper can be removed to install the chimney liner.
- 6) Must not have blocked circulating chambers (if available).
- 7) The means for removing the insert to clean the chimney flue.
- 8) Have a permanent metal warning label (provided with the Clydesdale—see following illustration) attached to the fireplace by riveting it to the outside wall, stating that the fireplace must be restored to its original condition for safe use without the insert.

This fireplace must be restored to its original condition for safe use without the insert.

- NOTE: When installing this unit as an insert, this label must be installed on/in the fireplace.

3300-625

Remember, you must adhere to all previously described floor protection requirements when installing into a zero clearance fireplace.

🔥 **WARNING: DO NOT CONNECT THE FIREPLACE INSERT TO A CHIMNEY FLUE SERVING ANOTHER APPLIANCE.**

Ensure the size of the chimney's flue is appropriate for the Clydesdale. The Clydesdale requires a 6" (152 mm) inside diameter flue for new installations. A 6" diameter flue provides adequate draft and performance. You can use an 8" (203 mm) diameter existing flue with a reducer. An oversized flue contributes to creosote accumulation. (In this case, bigger is NOT better.)

There are two ways to install a prefabricated metal chimney:

- 🔥 An *interior* installation where the chimney passes inside the residence through the ceiling and roof.
- 🔥 An *exterior* installation where the chimney passes through the wall behind the Fireplace Insert then up the outside of the residence.

Whenever possible, choose an interior chimney. An interior chimney heats quickly and retains its heat; thus promotes a better draft and discourages the formation of creosote. An exterior chimney does not benefit from the surrounding warmth of the building, so it typically operates at lower flue temperatures than an interior chimney. An exterior chimney's draft is not as strong and may experience increased creosote accumulation.

🔥 **REMOVE THE DAMPER OR LOCK IT OPEN.**

Connection to a Masonry Chimney

Hire a professional to examine the masonry chimney for cracks, loose mortar, and other signs of deterioration and blockage before connection. If the chimney needs repairs, complete them before installing and using your Fireplace Insert. Do not install your Fireplace Insert until the chimney is safe for use.

Ensure the chimney's cleanout is complete and working properly. To avoid a loss of draft, the cleanout must close off completely.

Ensure the size of the chimney's flue is appropriate for this Fireplace Insert and that it is not too large. Use a masonry chimney with a maximum 8" x 8" (203 mm x 203 mm) tile size for best results. An oversized flue will contribute to the accumulation of creosote.

Use the following checklist to ensure that your masonry chimney meets these minimum requirements:

Chimney wall construction:

- 🔥 A brick, modular block, rubble or stone wall at least 4" (102 mm) thick.

Flue liner:

- 🔥 Minimum ceramic flue liner thickness of 5/8" (16 mm). Installed with refractory mortar and with at least 1" (25 mm) air space.
- 🔥 An equivalent listed chimney flue liner system meeting type HT requirements or other approved material.

Interior chimney requirements:

- 🔥 At least 2" (51 mm) clearance to combustible structure
- 🔥 Fire stops installed at the spaces where the chimney passes through floors and/or ceiling.
- 🔥 Insulation must be 2" (51 mm) from the chimney.

Exterior chimney requirements:

- 🔥 At least 1" (25 mm) clearance to combustible structure.
- 🔥 Chimney height requirements: (See page 20)
- 🔥 At least 3 feet (0.9 m) higher than the highest part of the roof opening through which it passes.
- 🔥 At least 2 feet (0.6 m) higher than any part of the roof within 10 feet (3 m) measured horizontally from the top of the chimney. This Fireplace Insert requires a minimum chimney height of 13 feet (4 m). The maximum recommended chimney height is 30 feet (9m).
- 🔥 **IMPORTANT: You must seal the damper area around the chimney liner to prevent room air from entering the chimney cavity of the fireplace.**

🔥 **WARNING: DO NOT REMOVE BRICKS OR MORTAR FROM THE EXISTING FIREPLACE!**

(Exception) Removal of masonry or steel (including the damper plate) from the smoke shelf and adjacent damper frame if necessary to accommodate a chimney liner, provided their removal will not weaken the structure of the fireplace and chimney, and will not reduce protection for clearance to combustible materials to less than required by the National Building Code.

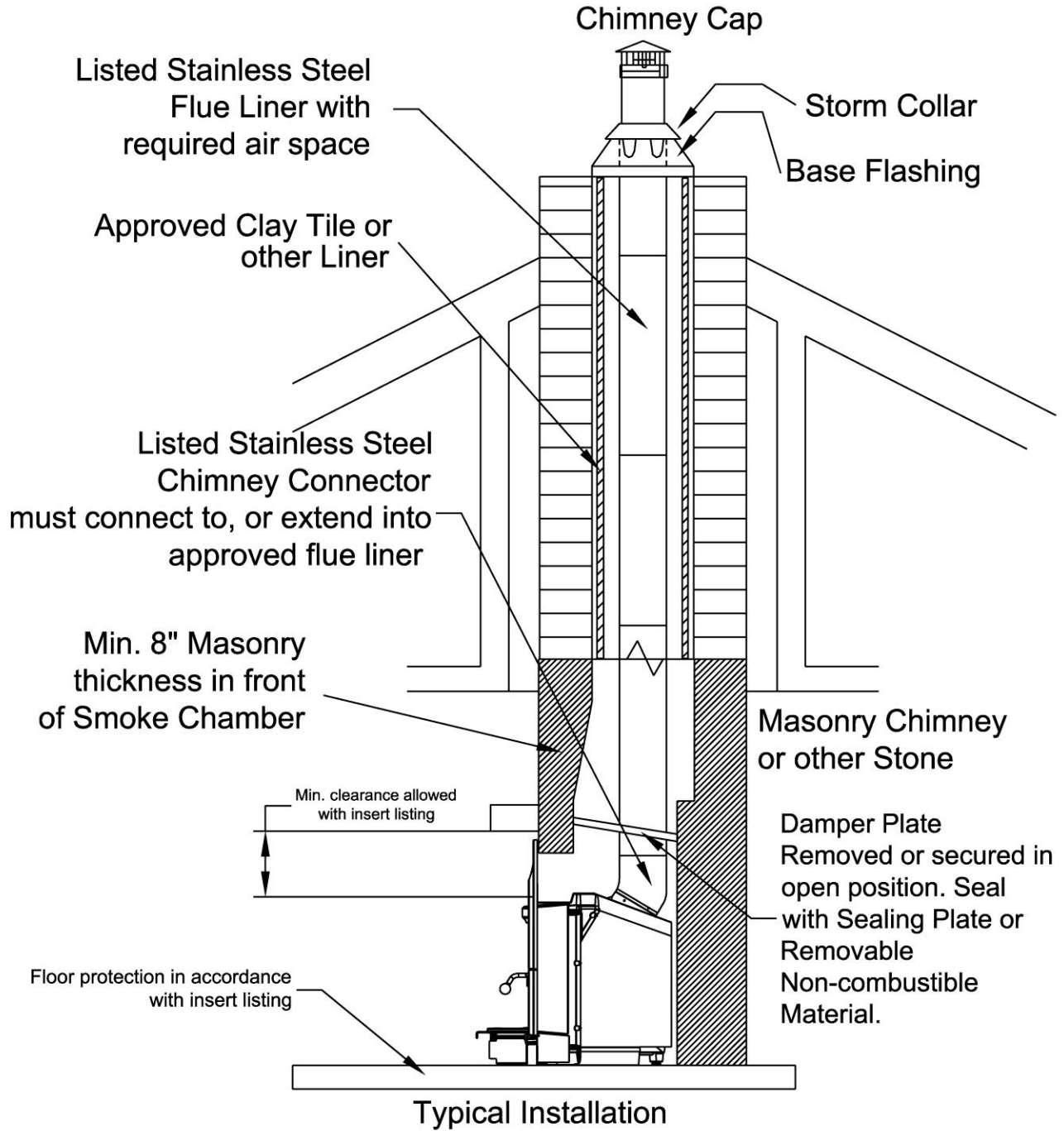

Figure 5 – Connecting to a masonry chimney

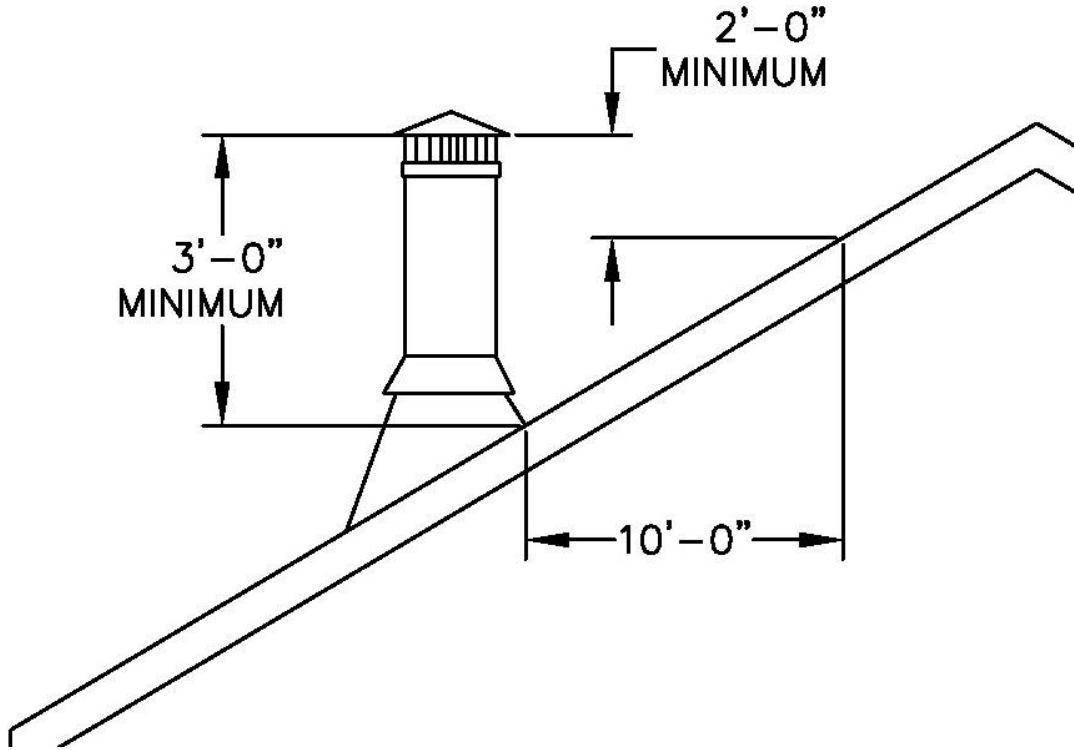

Figure 6 – The 2 / 10 / 3 Chimney Exit Clearance Rule

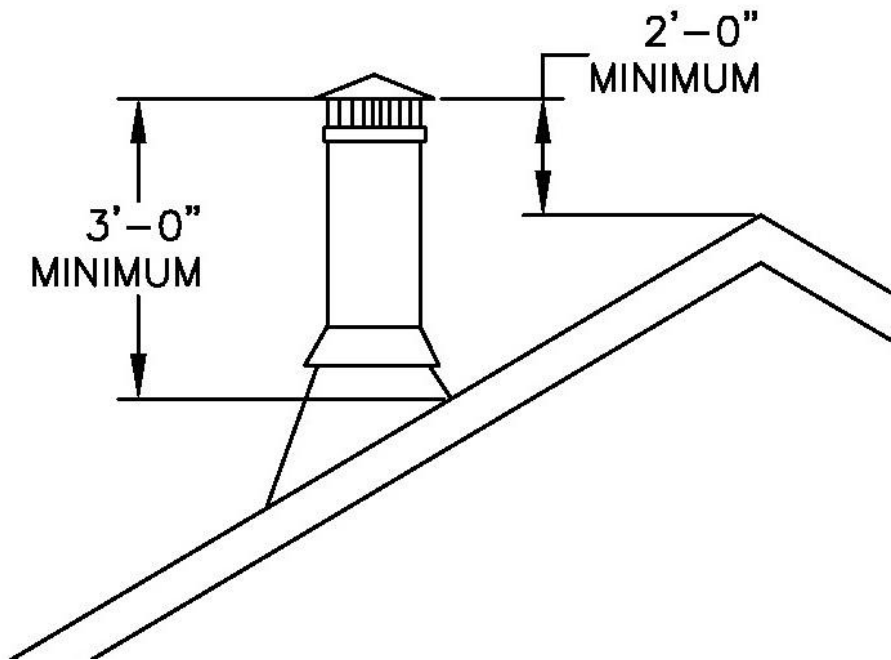

Figure 7 – Minimum Chimney Height Is 3' Even At the Ridge

Operation

- 🔥 **WARNING: HOT WHILE IN OPERATION. KEEP CHILDREN, CLOTHING AND FURNITURE AWAY. CONTACT MAY CAUSE SKIN BURNS.**

Please read this entire chapter before lighting your first fire. It explains the controls and features of your wood Fireplace Insert, how to choose firewood, burn rates, and how to break-in your Fireplace Insert and use it on a daily basis.

Controls & Features

- 🔥 **WARNING: ONLY OPERATE WITH DOOR FULLY OPEN OR CLOSED. IF DOORS ARE LEFT PARTLY OPEN, GAS AND FLAME MAY BE DRAWN OUT OF THE OPENING, CREATING RISKS FROM BOTH FIRE AND SMOKE**
- 🔥 **IF OPERATING WITH DOORS FULLY OPEN, YOU MUST USE THE ACCESSORY SCREEN AVAILABLE THROUGH YOUR HEARTHSTONE DEALER**
- 🔥 **DO NOT FORCE THE DOOR OPEN PAST THE DOOR STOP OR YOU COULD DAMAGE THE ENAMEL FINISH AND DOOR FRAME (ENAMELED STOVES ONLY).**

If operating with the door open, some fuels may create carbon monoxide, which can be hazardous or fatal to your health. Do not burn anything but clean, dry firewood

FRONT DOOR & LATCH: The front door allows you to load wood into your Fireplace Insert; a fixed handle allows you to operate the front door and allows you to latch the front door closed. The front door is reversible (hinges moved to the left) to open from the right side. To open the door, lift the handle to the 10 o'clock (or 2 o'clock for RH opening door) position, and pull out on the door. To latch the door, push the door closed tightly then lower the handle to the 8 o'clock (4 o'clock for RH opening door) position. Pull lightly on the door handle to ensure it is properly latched. **Do not force the door past the door stop if present; you could damage the door frame and finish.**

PRIMARY AIR CONTROL: The control handle is located on the front top center of the ash lip under the ash lip cover (see Figure 8). The primary air control allows you to regulate the amount of air entering the firebox. Generally, the more air allowed into the firebox, the faster and hotter the rate of burn; conversely, less air creates a slower burn. To fully open the primary air intake, pull the handle as far out as it will go away from the firebox; push the handle in as far as it will go towards the firebox to close the

primary air control. The control does not completely stop the flow of air.

Operating the Blower

The blower is factory installed within the front ash lip. The blower will run only when the insert is hot. The blower control (notched wheel) is located in the bottom center of the ash lip (see Figure 8). Routing the power cord to the left or right of the insert is possible - follow the instructions provided in the installation section.

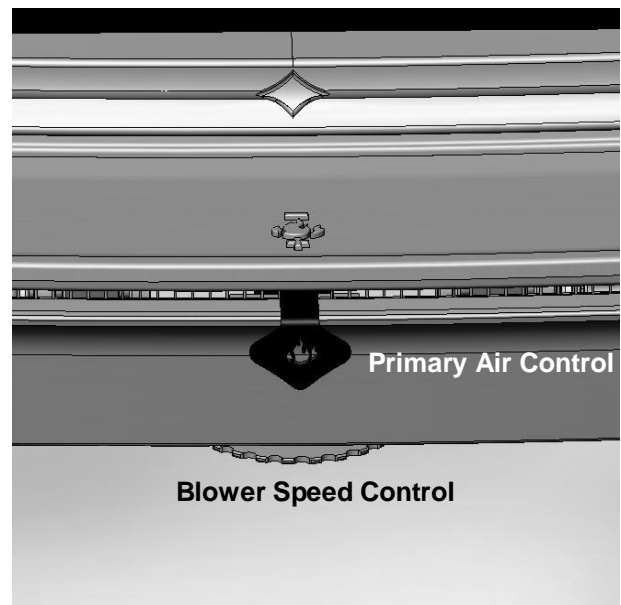

Figure 8 – Primary Air, & Blower Speed Controls

Choosing Firewood

Your Clydesdale Wood Burning Insert is designed to only burn natural firewood - also known as cordwood.

- 🔥 **CAUTION: DO NOT USE CHEMICALS OR FLAMMABLE FLUIDS SUCH AS GASOLINE, NAPHTHA, KEROSENE, CHARCOAL LIGHTER FLUID OR ENGINE OIL TO START A FIRE. DO NOT USE CHARCOAL, PELLETS, COAL, ARTIFICIAL LOGS OR ANY OTHER MATERIALS AS FUEL; THEY ARE NOT SAFE. DO NOT BURN GARBAGE.**

The quality of your firewood affects heat output, duration of burn and performance of your Fireplace Insert. Softwoods generally burn hotter and faster, while hardwoods burn longer and produce more long lasting coals. Density and moisture content are two critical factors to consider when purchasing wood for your Fireplace Insert.

The following is a list of wood species and their relative BTU (British Thermal Unit) content. The higher the BTU content the longer the burn. Firewood with higher a BTU content is generally considered ideal for a wood stove.

Wood Heat Value: Sorted By Btu Content

Common Name	Lb/ cord	MBTU/ cord
High		
Osage Orange (Hedge)	4,728	32.9
Hickory, Shagbark	4,327	27.7
Hop Hornbeam (Ironwood)	4,267	27.3
Beech, Blue (Ironwood)	3,890	26.8
Birch, Black	3,890	26.8
Locust, Black	3,890	26.8
Hickory, Bitternut	3,832	26.7
Locust, Honey	3,832	26.7
Apple	4,100	26.5
Mulberry	3,712	25.8
Oak, White	4,012	25.7
Medium High		
Beech, European	3,757	24
Maple, Sugar	3,757	24
Oak, Red	3,757	24
Ash, White	3,689	23.6
Birch, Yellow	3,689	23.6
Medium		
Juniper, Rocky Mtn	3,150	21.8
Elm, Red	3,112	21.6
Coffeetree, Kentucky	3,112	21.6
Hackberry	3,247	20.8
Tamarack	3,247	20.8
Birch, Gray	3,179	20.3
Birch, White (Paper)	3,179	20.3
Walnut, Black	3,192	20.2
Cherry	3,120	20
Ash, Green	2,880	19.9
Cherry, Black	2,880	19.9
Elm, American	3,052	19.5
Elm, White	3,052	19.5
Sycamore	2,808	19.5
Ash, Black	2,992	19.1
Maple, Red	2,924	18.7
Fir, Douglas	2,900	18.1

Medium Low

Boxelder	2,797	17.9
Alder, Red	2,710	17.2
Pine, Jack	2,669	17.1
Pine, Norway (Red Pine)	2,669	17.1
Pine, Pitch	2,669	17.1
Catalpa	2,360	16.4
Hemlock	2,482	15.9
Spruce, Black	2,482	15.9
Pine, Ponderosa	2,380	15.2

Low

Aspen, American	2,290	14.7
Butternut (Walnut, White)	2,100	14.5
Spruce	2,100	14.5
Willow	2,100	14.5
Fir, Balsam	2,236	14.3
Pine, White (Eastern, Western)	2,236	14.3
Fir, Concolor (White)	2,104	14.1
Basswood (Linden)	2,108	13.8
Buckeye, Ohio	1,984	13.8
Cottonwood	2,108	13.5
Cedar, White	1,913	12.2

Moisture content also plays a key role in the performance of your stove. Wood freshly cut from a living tree (green wood) contains a great deal of moisture. As you might expect, green wood has difficulty burning and should be seasoned before using it in your wood stove. To properly season green wood: split, stack and allow to air dry for a period of one year.

Stack the firewood on skids or blocking to keep it off the ground, cover only the top of the stack. Plastic or tarps that cover the sides of the stack of wood trap moisture and prevent the wood from drying. As for stacking, an old Vermonter said, "The spaces between the logs should be large enough for a mouse to get through, but not for the cat that's chasing it."

 **Do not store Firewood within the Fireplace Insert's specified clearances to combustible materials.**

Hearthstone's Thermo-Ceramic Baffle System

To enhance the combustion efficiency and reduce the particulate emissions of the fire in your stove, Hearthstone has developed an advanced THERMO-CERAMIC baffle system. This system uses a lightweight, durable ceramic material above the secondary air tubes to maintain high temperatures in the secondary combustion area to promote low emissions and high efficiency combustion. This material will not corrode, rust, dissolve, or lose its strength, however it is vulnerable to puncture or breakage due to rough handling.

Please Exercise Care When Loading Wood or Cleaning Your Insert, To Not Damage the Thermo-Ceramic Baffle

Located directly above the air tubes in the top of the firebox, this white or gray sheet of material will break if wood or cleaning brushes impact it. Use care when loading and cleaning your stove to avoid breaking this material. If the baffle fractures or a hole is punctured, the stove will function improperly. You must replace the board through a qualified Hearthstone dealer.

Building a Fire

Once you understand the controls of your Clydesdale Fireplace Insert, and have chosen the appropriate firewood, you are ready to start a fire.

Breaking in Your Wood Fireplace Insert

It is imperative that you "break in" the Fireplace Insert slowly. Cast iron must be "seasoned"; over-firing a new Fireplace Insert may cause castings to crack or may damage other Fireplace Insert parts. Slowly driving the moisture out of the soapstone bricks lining the firebox will minimize the "shock" to the stone at its first exposure to high firebox temperatures.





When you light your first fires, the Insert will emit some smoke and fumes. This is normal "off-gassing" of the paints and oils used when manufacturing the Fireplace Insert. If you find it necessary, open a few windows to vent your room. The smoke and fumes will usually subside after 10 to 20 minutes of operation. The odor and smoke will end once the Fireplace Insert is "cured".

The first fires may also produce other odors from "impurities" that exist in the area immediately

surrounding the Fireplace Insert. Some of these impurities are residues of cleaning solvents, paint solvents, cigarettes, candle soot, pet hair, dust, adhesives, a new carpet, and new textiles. These odors will dissipate over time. You can alleviate these odors by opening a few windows or otherwise creating additional ventilation around your Fireplace Insert. If any odor persists, contact your dealer or an authorized service technician.

If you adhere to the break-in procedure, as well as all other operating procedures in this manual, the cast iron and soapstone firebox lining of your Fireplace Insert will give you many years of trouble-free use.

Avoid the following conditions that can cause the soapstone or cast iron pieces to break:

-  Do not throw wood into the Fireplace Insert.
-  Do not use the door as a lever to force wood into the Fireplace Insert.
-  Do not load wood that is encrusted with ice into a burning, hot stove as the thermal shock can cause damage.
-  Do not use a manufactured log grate. Burn the fire directly on the soapstone that lines the bottom of the firebox.

The bottom layer of soapstone in the firebox is intended to prevent thermal stress to the cast iron, and should remain in place at all times.

Do not over-fire the Fireplace Insert. (Refer to page 25).

Building a Break in Fire

1. Open the front door and place five or six double sheets of tightly twisted newspaper in the center of the firebox. Arrange kindling in a crisscross pattern over the newspaper. Kindling should be approximately ten pieces, 1/2" (13 mm) in diameter and 10" to 18" (254 mm to 457 mm) long.
2. Fully open the primary air control by pulling the control handle fully out, away from the firebox.
3. Light the paper under the kindling. Leave the front door slightly ajar momentarily until the kindling has started to burn and draft begins to pull.
4. Close the door and allow the fire to burn. Keep the front door closed while the Fireplace Insert is in use.
5. Keep a watchful eye on your fireplace insert to maintain a steady, low-heat fire. Your first fire should make the Fireplace Insert warm, but **not**

hot to the touch. At most, add only a few small chunks of wood to the fire to reach safe break-in temperatures.

6. Once the Fireplace Insert is warm but **not hot to the touch**, close the primary air control by pushing it in fully toward the firebox to allow the fire to die out completely.
7. Let the Fireplace Insert return to room temperature.

Your first fire and first fire each season thereafter should be built and maintained as outlined above. Your patience will be rewarded by a properly seasoned Fireplace Insert.

 **Note:** Because of the cool flue gas temperatures present during the break-in procedure, creosote may build up rapidly. Your door glass may also get dirty. A good hot fire will clean it. We recommend a visual inspection (and cleaning if necessary) of your stovepipe and chimney once the break-in procedure is completed.

Operating Your Insert Efficiently

Hearthstone designed your Clydesdale insert to burn firewood cleanly and efficiently. The following operational tips explain how to obtain the most heat possible with minimal creosote build-up and emitted pollutants.

Burn Rate

There are four basic burn rates: high burn, medium burn, low burn, and overnight burn. Each has its own purpose.

High Burn Rate: We recommend a high burn rate once or twice a day to fully heat the stove and chimney; this also helps keep the amount of creosote in your stove and chimney to a minimum.

After the fire is established and both the stove and chimney are hot, create a high burn for maximum heat output. Pull the primary air control out so that it's fully open or almost fully open. Fully load the firebox with wood on a bed of hot coals or on an actively flaming fire.

After you have attained a high burn rate, monitor the stove temperatures frequently to ensure that the stove is not over-fired. The surface temperature on top front of the insert (firebox body under grill) should not routinely exceed 600° Fahrenheit (316° Celsius). Once you understand how your insert burns and heats in your particular setting, you can easily create a high burn rate without risk to the stove or chimney.

When your room's temperature is comfortable, maintain your fire by loading smaller quantities of wood. Burning smaller amounts of wood at a high burn rate creates the least amount of creosote in your chimney, emits the lowest amount of pollutants, but provides shorter burn times.

Medium to Medium Low Burn Rate: In general, you would usually create a medium to medium low burn rate, especially if your stove is left unattended periodically. Set the primary air control to a mid-range setting, appropriate to maintain a comfortable temperature in the heated area. This setting produces the most efficient overall burn.

Low Burn Rate: Close the primary air control for a low burn rate. This setting provides the longest burn time. However, set a low burn rate only periodically. Over extended periods, a low burn rate promotes the accumulation of creosote. If you consistently maintain low burn rates, inspect your venting system frequently.

Overnight Burn Rate: An overnight burn, as you might expect, allows you to keep an area heated while you sleep. To create an overnight burn, first ensure the stove and chimney is hot from an established fire. Next, pull the primary air control fully open, and then completely load the firebox with wood. Remember, larger pieces of wood burn longer. Allow the fire to burn intensely for 20 to 30 minutes.

Finally, push the primary air control *close to* its lowest setting; the fire will settle into a lower burn rate with a small flame and more secondary gas ignition. The fire will now burn slowly and steadily. The longevity and intensity of the fire depends on the type, size and quality of the wood, the strength of the chimney draft, and other variables that vary from installation to installation. High draft installations or situations may require using a low burn rate setting.

In the morning, you should find a bed of hot coals buried within the ashes. The insert should be warm to the touch but not hot. To restart the fire without relighting, simply stir and rake the ashes with a poker until the hot coals have come to the surface. Place a handful of kindling and a few small logs on the coals, close the door, and fully open the primary air control. The fire should re-ignite within 5 to 10 minutes. Once the fire is burning well, add a few larger logs, close the door, leave the primary air control fully open, and allow the fresh logs to ignite.

Running a high burn rate at least once a day burns off accumulated creosote from within the insert and

venting system. Now, in the morning after an extended low burn rate, is a good time to create your daily high burn rate; run it for about 20 minutes or so. Not only does this hot fire promote a clean stove and chimney, it also helps keep the glass cleaner for easy viewing of the fire within.

Once the fire is burning briskly, regulate the primary air control to a medium setting for a medium, to medium low burn rate.

Intermittent Operation

If your Fireplace Insert is not used continuously or has not been used in quite some time, follow the break-in procedure at least once to minimize the stress of a hot fire on a cold Fireplace Insert before proceeding with normal operation. We recommend one break-in fire at the start of each heating season.

Building a Fire for Everyday Use

1. Open the front door and place five or six double sheets of tightly twisted newspaper in the center of the firebox. Arrange kindling in a crisscross pattern over the newspaper. Use about ten pieces of kindling approximately 1/2" (13 mm) in diameter and 10" to 18" (254 to 457 mm) long. You can place two or three small logs on top of the kindling if desired.
2. Fully open the primary air control by pulling the control handle fully out, away from the firebox.
3. Light the paper under the kindling. Leave the front door slightly ajar until the kindling starts to burn and draft begins to pull.
4. Close the door and allow the fire to burn.
5. If you did not add small logs in step 1, do so once the kindling is burning well. Open the front door and add small logs. Ensure you keep the logs away from the glass in front in order for the air-wash system to work properly. Otherwise, keep the door closed while the insert is in use.
6. Once the fire is burning well, add larger wood pieces to build the fire up. Use the primary air control to regulate the desired rate of burn. Pull the handle out to open the PRIMARY AIR CONTROL for a high rate of burn; push it in to reduce the primary air for a lower rate of burn.

 **Note:** When opening the front door to reload or re-arrange logs, open the door just a crack first, pause for a moment, then open the door completely. This procedure allows the firebox

to clear of smoke before the door opens fully. Also, reloading on a bed of hot, red coals reduces smoking time and will bring fresh fuel up to a high temperature rapidly.

Disposal of Ashes

Place ashes in a metal container with a tight fitting lid. Place the closed container of ashes on a non-combustible floor, or on the ground outside, well away from all combustible materials or fumes, pending final disposal. If ashes are disposed of by burial in soil or otherwise locally dispersed, retain them in the closed container until all cinders have thoroughly cooled.

Over-Fire Caution

Over-firing means the Fireplace Insert is operating at temperatures above the recommended temperatures outlined above in the *BURN RATE* section. Carefully avoid over-firing since it will cause damage to the Fireplace Insert. Symptoms of over-firing include short burn times, a roaring sound in the Fireplace Insert or chimney, and discoloration of the finish.

Over-firing can be caused by excessive draft, inappropriate fuel, and operator error. Correct an over-fire situation as follows:

EXCESSIVE DRAFT: Contact your dealer to have a draft reading taken.

INAPPROPRIATE FUEL: Do not burn coal; kiln dried lumber, pellets, wax logs, plastics, trash or anything other than natural cordwood.

OPERATOR ERROR: Ensure all the gaskets are in good condition. Replace worn out or compressed gaskets. Do not burn the Fireplace Insert with the front door in a partially open position. The door must be fully closed or opened completely (e.g. when using viewing screen).

If you suspect that your Fireplace Insert is over-firing, contact your dealer immediately. **Damage done by over-firing is not covered by your warranty.** Results of over-firing can include: warped or burned out internal parts, cracked firebox soapstone, discolored or warped external parts, and damaged enamel.

 **NOTE: ANY SYMPTOMS OF OVER-FIRING WILL VOID YOUR WARRANTY!**

Maintenance

Creosote Formation and Need for Removal

Wood, when burned slowly, produces tar and other organic vapors, which combine with expelled moisture to form creosote. These creosote vapors condense in the relatively cool chimney flue of a slow-burning fire. As a result, creosote residue accumulates on the flue lining. When ignited, this creosote makes an extremely hot fire, which may damage the chimney or even destroy the house. Inspect the flue liner and chimney at least once every month during the heating season to determine if there is a creosote buildup.

To prevent the buildup of creosote:

1. Burn the Fireplace Insert with the primary air control fully open for 20 - 40 minutes daily to burn out creosote deposits from within the Fireplace Insert and the venting system.
2. After reloading with wood, burn the Fireplace Insert with the primary air control fully open for 20 to 30 minutes. This manner of operation ensures early engagement of the secondary combustion system which, when engaged, minimizes creosote buildup in the chimney.

If a creosote residue thicker than 1/4" (6 mm) accumulates, remove it to reduce the risk of a chimney fire.

If your glass always remains dirty, your operating temperatures are probably too low, or your wood is not dry enough; therefore, there is a higher risk of creosote buildup.

Inspect the venting system for creosote at the Insert connection *and* at the chimney's top. Cooler surfaces tend to build creosote deposits faster, so it is important to check the chimney at the top (where it is coolest) as well as from the bottom at the Insert.

Remove accumulated creosote with a cleaning brush specifically designed for the type of chimney in use. Use a certified chimney sweep to perform this service. Contact your dealer for the name of a certified chimney sweep in your area (your dealer may be a certified sweep!).

We recommend that you have the entire system professionally inspected, cleaned, and repaired if necessary, before each heating season.

Gaskets

Depending on use, replace gasket materials every two to three seasons. If the door seal is leaking, a new gasket will assure a tight seal and improved performance. Contact your dealer for a gasket kit that includes instructions and gaskets for your Fireplace Insert.

To replace the door gasket, first remove the old gasket with a utility or putty knife. Clean all gasket channels with a wire brush. Apply gasket cement to the channels and push the new gasket into place without stretching the gasket material. Immediately close the door to fully press the gasket into place and assure a positive seal.

Glass

Do not operate the Fireplace Insert with a broken door glass. Do not abuse the front door by striking or slamming.

When necessary, clean the glass with low alkaline content commercial stove glass cleaners, which are available from your local dealer. Never attempt to clean the glass while the fire is burning, or if the glass is hot. Most deposits are easily cleaned by following the instructions provided with the cleaner. To clean heavier deposits, remove the door from the Fireplace Insert (take care to save hinge pins and spacers for reuse). Lay the door face down on a workbench or table with the handle hanging over the edge. Apply the cleaner to the glass and allow it to sit for a few minutes. Placing the door flat, it will allow the cleaner to penetrate rather than running off the surface of the glass. Wipe the cleaner off with a soft cloth.

 **Important:** scratching or etching the glass will weaken the integrity of the glass. Do not use a razor blade, steel wool, or any other abrasive material to clean the glass. Use low alkaline content cleaners only.

The front door glass is a ceramic, shock-resistant glass, made specifically for use in woodstoves. Do not use any replacement glass other than the ceramic glass manufactured and supplied for use in this woodstove. Replacement glass is available through your local dealer.

Replace the door glass immediately if broken. Contact your local dealer for a replacement glass kit. The glass kit comes with instructions and everything

needed for the repair. If you replace the glass yourself, wear work gloves and safety glasses.

Door removal and glass and glass gasket replacement procedure is as follows: Refer to *Figure 9*.

1. Cover the Ash Lip Cover with cardboard or an old towel to avoid scratching it.
2. Remove the door by opening it about 45 degrees, support the door and remove the bottom hinge pin, then lift the top hinge pin until it clears the door hinge section. Move the door out and away from the insert.
3. Place the door face down on a flat, smooth surface.

4. Apply penetrating oil to the screws. Remove the screws to separate the glass retainer from the door.
5. Carefully lift the damaged glass from the door casting and discard.
6. Replace the screws.
7. Install the door.

WARNING: DO NOT USE SUBSTITUTE MATERIALS WHEN REPLACING THE GLASS OR ANY DOOR COMPONENTS. USE ONLY AUTHORIZED HEARTHSTONE COMPONENTS.

Glass specifications: 320mm x 583mm x 5mm (12-5/64" x 22-15/16" x 0.197") Neoceram.

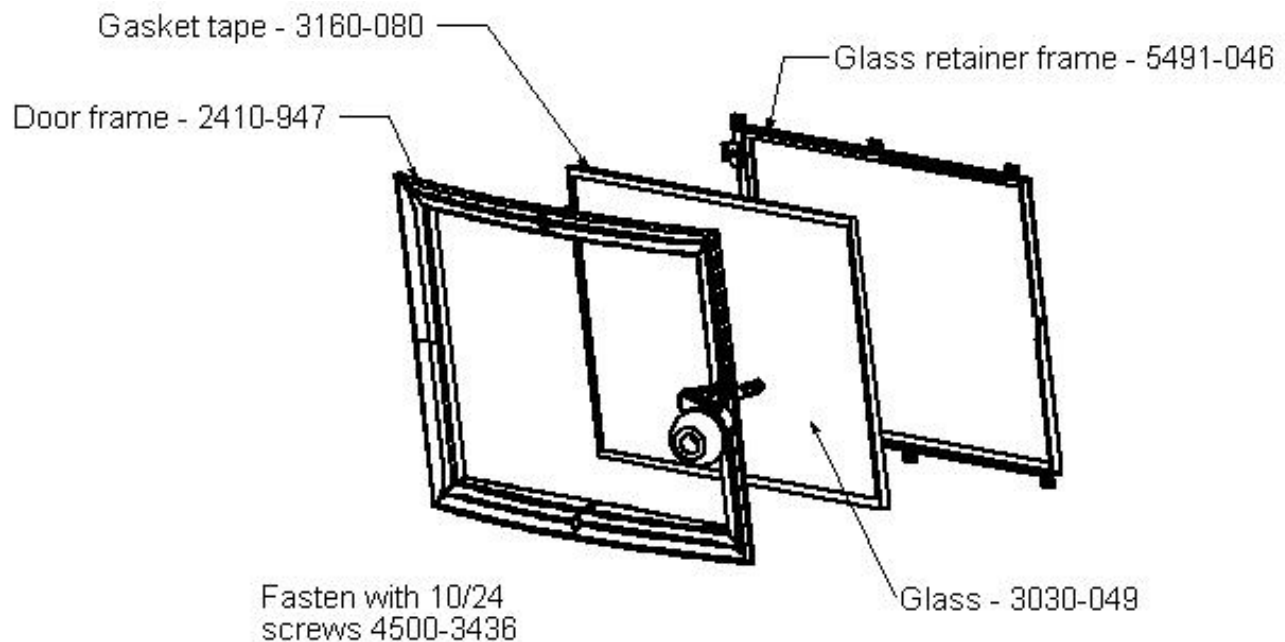

Figure 9 – Glass Replacement Components

Cast Iron

Exterior cast iron parts are either painted with black, high-temperature stove paint or porcelainized with enamel finishes in various colors.

Use black, high-temperature stove paint (we recommend satin black by Stove Bright) to touch up and maintain the original appearance of painted cast

iron. Use a damp sponge to wipe clean. Dry the cast iron thoroughly to prevent rusting.

Clean enameled castings with a standard glass cleaner. With time and use, a very fine, subtle network of lines, commonly known as crazing, may appear seemingly beneath the surface of the enamel. Crazing is a natural predictable process and does not represent a flaw.

Blower System

For maximum efficiency, the blower system will require periodic cleaning to remove dust that will accumulate during normal use. To access the blower system, you must remove the Ash Lip Cover as described in the installation section of this manual.

Remove the Ash Lip Cover and carefully vacuum components. Take care to avoid bending the fins on the blower fans. Inspect all wiring and mounting hardware for damage or deterioration.



Photo 30 – Blower System (Ash Lip Cover Removed)

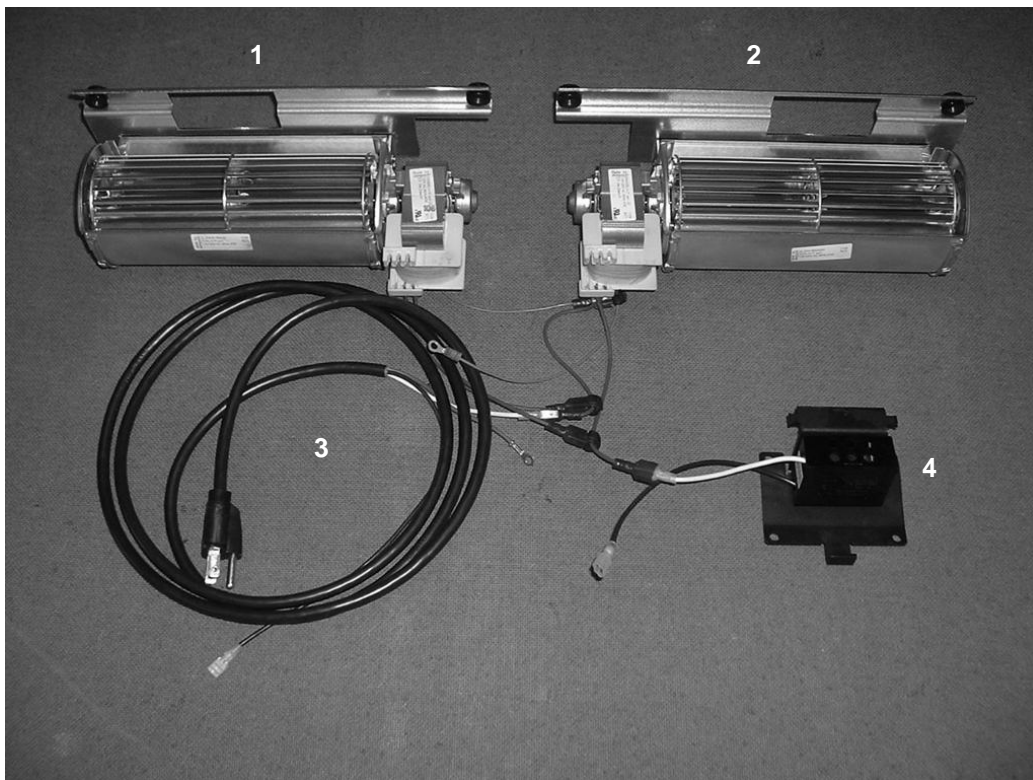

Photo 31 – Blower Kit Major Components (Kit 94-57910)

1. Left Blower Fan Assembly
2. Right Blower Fan Assembly
3. Power Cord
4. Speed Control with Bracket

Troubleshooting

Basic Heating Issues

Virtually all woodstove operators experience basic common problems at one time or another. Most are correctable and generally require only a minor adjustment of the stove, installation, or operating technique. In cases where weather conditions dramatically affect stove performance, the problems are typically temporary and resolve themselves once the weather changes.

Keep in mind that your house itself regulates room/house temperatures. How well the walls, floors and ceilings are insulated, the number and size of windows, the tightness of exterior doors, and the construction or style of your house (vaulted ceilings or other open spaces which collect large percentages of heat, ceiling fans, etc.) all are determining factors of room temperature.

Your Insert's performance is also greatly dependent on its installation. One common cause of poor performance is inadequate draft. An oversized chimney flue is commonly the cause. Oversized flues result in decreased vacuum, which prevents the smoke from rising out the chimney. Oversized flues are also more difficult to heat effectively, especially when burning a high efficiency insert like the Clydesdale. Cool flue temperatures inhibit the establishment of a strong draft (and encourage accumulation of creosote). The lack of a strong draft will cause the fire to die down and may even force smoke into the room. If your chimney is the proper size and a strong draft is not easily established, there is the possibility the chimney is just too cold. Again, hot chimneys promote a stronger draft. Other draft issues and guidelines are as follows:

1. **AN "AIRTIGHT" HOUSE:**
 - a. Inadequate infiltration air supply in a super-insulated or especially well sealed home.
 - b. Air starvation exacerbated by exhaust fans, such as clothes dryers, bathroom vent fans, or cook stove exhaust fans.
2. **TALL TREES OR BUILDINGS:**
 - a. These obstructions, in close proximity to the top of the chimney can cause chronic or occasional downdrafts.
 - b. Consider the placement of other objects when selecting a site for a new chimney.
3. **WIND VELOCITY:**
 - a. Strong, steady winds generally create a strong (better) draft.

- b. "Gusty" wind conditions may cause erratic downdrafts. Strong winds can produce a negative pressure condition in the upwind side of a structure.
4. **BAROMETRIC PRESSURE:**
 - a. Chimney drafts are typically sluggish on balmy, wet or muggy days (low or falling barometric pressure). This is generally self-correcting as the weather changes.
5. **BRISKNESS OF FIRE:**
 - a. The hotter the fire, the hotter the chimney and, therefore, the stronger the draft.
6. **SEASONAL FACTORS:**
 - a. Early fall and late spring are generally difficult seasons in which to establish proper drafts. The colder the outside air is (relative to room temperatures) the stronger the draft.
7. **OPERATING THE FIREPLACE INSERT:**
 - a. There are days when a draft is just not easily established. As outlined above, seasonal factors or a cold chimney may be the cause.
 - b. Starting the fire using small kindling and small wood pieces to obtain a quick, hot fire. Tend the fire frequently with small pieces until the chimney is hot and the draft is well established.
 - c. Briefly partially open a window in the room with the insert to help establish a draft quickly.

Draft Sampling Access Port

The draft sampling port is located under the top grill on the front center of the stove's body. Remove the bolt or setscrew and nut to check the draft reading. Ensure you replace the plug when finished.

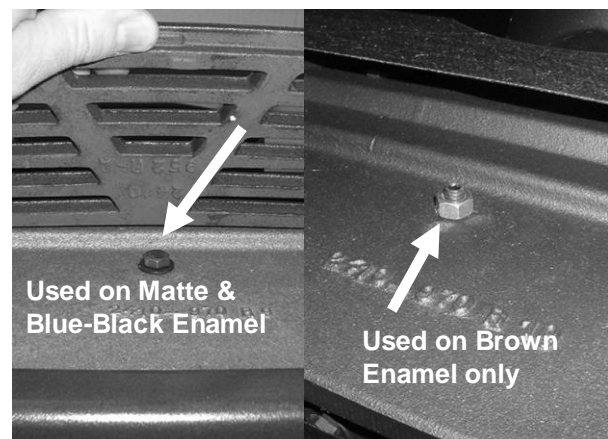

Photo 32 – Draft Port Detail

Troubleshooting Guide

PROBLEM	POSSIBLE CAUSE	SOLUTIONS
INSERT SMOKES	Operating Technique	Fully open the primary air control one minute before opening door. Open front door slightly until firebox clears of smoke, then open fully.
	Cold Chimney	Preheat the chimney when first starting a fire.
	Reverse Draft at Startup	Turn off all exhaust fans in home. Open window in room with unit until draft is established.
	Blocked Flue	Examine the chimney liner and cap for blockage or creosote accumulations. Check top of baffle for accumulated flue ash.
	Oversized Chimney	Reline the chimney to the appropriate diameter
	Undersized Chimney	Install a draft inducer or replace the chimney.
	Chimney Too Short	Lengthen the chimney.
	Incorrect installation	Ensure metal flue liner extends the full length of chimney and is connected securely to the flue collar. Or, with masonry liner, ensure flue connector is sealed tightly to inside of chimney where it passes through the fireplace damper area.
	Air Infiltration Into Chimney	Seal all chimney and liner connections and any openings in or around clean-out doors.
	More Than One Appliance Connected to the Flue	Disconnect all other appliances and seal openings.
BACK-PUFFING OR GAS EXPLOSIONS	Operating Technique	Fully open the primary air control one minute before opening the door and keep it fully open for a few minutes after reloading.
	Extra Low Burn Rate	Burn the Fireplace Insert at a higher burn rate.
	Using accelerant	NEVER use accelerants to start or invigorate the fire.
	Chimney Down-draft	Install a chimney cap. Check chimney installation
	Excessive Ash Build-up	Empty ashes more frequently.
UNCONTROLLED OR SHORT BURN	Unsealed or Open Door	Close the door tightly or replace the gaskets.
	Primary Air Control not operating properly	Ensure Primary Air control shutter is opening and closing when control lever is moved. Note: Shutter is not designed to close completely.
	Deteriorated Gasket Seals	Reseal the Insert body with new gaskets where necessary.
	Extra Long Chimney	Shorten the chimney. Install a damper/restrictor in flue.
	High Winds or Hilltop Location:	Install a chimney cap.
	Oversized Chimney	Reline the chimney to the proper diameter.
	Over-Fire Damage	Inspect unit – replace damaged or warped components.
INSUFFICIENT HEAT	Poor Quality or Green Wood	Use only air-dried wood, preferably dried at least one year.
	Burn Rate Too Low	Operate the Insert at a higher burn rate.
	Blocked Flue	Examine the chimney liner and cap for blockage or creosote accumulations. Check top of baffle for excessive flue ash.
	Air Insulated Chimney	Replace with a pre-fabricated insulated chimney system or a properly sized and lined masonry chimney.
	Cold Exterior Chimney	Reline or insulate the chimney.
	Leaky flue connector or Chimney liner	Check the installation – ensure connector is securely attached to flue collar. Check liner joints.
	Too Much Heat Loss From House	Caulk windows, seal openings in home. Increase energy efficiency of home.
DIRTY GLASS	Poor Quality or Green Wood	Use only air-dried wood, preferably dried at least one year.
	Burn Rate Too Low	Operate the Fireplace Insert at a higher burn rate.
	Leaky flue connector or Chimney Liner	Check the installation – ensure connector is securely attached to flue collar. Check liner joints.
BLISTERING OF ENAMEL CASTING	Operating Technique	Do not over-fire the Insert. Monitor Insert temperatures. Use seasoned cord wood only.
	Excessive Draft	Check gasket seals. Check chimney height. Install flue damper/restrictor. Install chimney cap.

Replacement Parts & Optional Accessories

PART NUMBER:	DESCRIPTION:	PART NUMBER:	DESCRIPTION:
CASTINGS:*		STEEL PARTS:	
2410-901	BOTTOM	5470-039	LEVEL, SURROUND
2410-905	BACK	5490-010	AIR SHROUD, BOTTOM
2410-910	LEFT SIDE	5940-012	PRIMARY AIR CONTROL
2410-915	RIGHT SIDE	5940-013	PRIMARY AIR GATE
2410-926	ASH LIP/BLOWER HOUSING, FRONT	5940-014	PRIMARY AIR GATE CAP
2410-927	ASHLIP/BLOWER HOUSING, TOP	5490-020	SURROUND CLIP
2410-940	PRIMARY AIR MANIFOLD	5490-050	STONE CLIP, REAR
2410-946	FRONT	5490-055	STONE CLIP, SIDE
2410-947	CASTING, DOOR	5490-058	COLLAR, PLENUM, SEC., LEFT
2410-951	FRONT FAÇADE	5490-059	COLLAR, PLENUM, SEC., RIGHT
2410-955	SECONDARY AIR PLENUM CONNECTOR	5490-071	SECONDARY AIR TUBE #1
2410-960	SECONDARY AIR PLENUM, LEFT	5490-072	SECONDARY AIR TUBE #2
2410-965	SECONDARY AIR PLENUM, RIGHT	5490-073	SECONDARY AIR TUBE #3
2410-970	TOP	5490-074	SECONDARY AIR TUBE #4
2410-975	FLUE COLLAR	5490-075	CLIP, BAFFLE
2410-991	SURROUND, STRAIGHT	5490-080	BAFFLE SUPPORT S.S.
2410-993	SURROUND, LEFT	5491-011	SHROUD
2410-994	SURROUND, RIGHT	5491-012	CLIP, ASHLIP COVER
		5491-013	HANDLE, AIR CONTROL
		5491-014	WHEEL, SPEED CONTROL
		5491-015	BRACKET, SPEED CONTROL
		5491-027	BRACKET, BLOWER, RIGHT
		5491-030	BRACKET, BLOWER, LEFT
		5491-035	SCREEN, ASHLIP
		5491-043	PLATE, CONNECTOR, SRRND
		5491-085	HINGE, DOOR
		5491-087	SLIDING BRKT, SURROUND
		7000-301	SNAP DISC
KITS:		SOAPSTONE:	
94-57910	BLOWER ASSEMBLY KIT	1-0000-101	STONE, REF, 4.5"x9x1.25"
7000-130	GROMMET, SILICONE	1-0400-900	STONE, REF, 4.5"x12"
7000-135	SLEEVE, GROMMET	1-0400-901	STONE, REF, 4.5"x11.25"
7200-601	CONTROL, SPEED, BLOWER	1-0400-902	STONE, REF, 4.5"x4.5"
7211-946	FAN, BLOWER, RT		
7211-947	FAN, BLOWER, LT	MISC:	
94-58910	GLASS KIT	3120-490	BOARD, CERAMIC, BAFFLE, CLY
3030-049	CLYDESDALE GLASS	3300-617	RATING LABEL
3160-080	GASKET TAPE, ADHESIVE BACK	3300-618	EPA HANG TAG, CLYDESDALE
94-58912	DOOR GASKET KIT		
3160-080	GASKET TAPE, ADHESIVE BACK		
3110-051	GASKET ROPE, LOW DENSITY, 1/2"		
99-090N	GLUE: GASKET, 2 OZ.		
94-71910	HANDLE KIT: FRONT DOOR, CLY 1		
3900-190	HANDLE: WOOD		
4100-0310	SCREW: SHOULDER 5/16x1 1/4"		
4600-0300	WASHER: FLATA, 1/4"		
94-73910	LATCH: DOOR, CLY 1		
5491-048	LATCH ASSEMBLY, DOOR, CLY 1		
4500-2976	SCREW: SET, 5/16-18x3/8"		
4700-0790	SPACER: DOOR LATCH		
5021-032	WASHER: FLAT		
5240-138	SPRING: LATCH		

*All are matte part numbers.

Clydesdale Accessories:

94-5991110 Matte Surround Kit
 94-5970610 Matte Surround Caps
 94-5970659 Blue/Black Enamel Surround Caps

94-79700 Mantle Shield
 94-69900 Screen Kit
 94-5990010 Matte Surround Extension

Safety Label

CONTACT YOUR LOCAL BUILDING
AND INSTALLATION

OFFICIALS ABOUT RESTRICTIONS
INSPECTION IN YOUR AREA



Listed Room Heater, Solid Fuel Type

Manufactured by:



317 Stafford Ave.
Morrisville VT 05661
USA

WN 12309

Intertek Testing
Services NA, inc.

"PREVENT HOUSE FIRES"

Install and use only in accordance with
manufacturer's installation instructions and
your local building codes.

Connect to a code-approved masonry chimney
or listed factory-built fireplace chimney with a
direct flue connector into the first chimney liner
section.

CAUTION: Special methods are required when
passing chimney through a wall or ceiling, refer
to local building codes. Do not connect this unit
to a chimney flue serving another appliance.

NOTE: Replace glass only with 5mm CERAMIC
or NEOCERAM glass.

SERIAL #

MODEL NAME: CLYDESDALE 8491

TESTED TO: UL 1482, ULC S628, UL 737

TYPE OF FUEL: Solid Wood Only

WARNINGS :

Risk of smoke and flame spillage,
operate only with doors fully open
or fully closed.

Do not obstruct space under heater.

Do not use grate or elevate fire. Build
wood fire directly on stone.

Do not overfire. If the heater or
chimney connector glows, you are
overfiring.

Clearance to Combustible Materials*

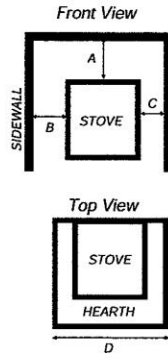

- A - 27" (69cm)
- A - 11" (28cm) with Mantle Shield
- B - 12" (31cm)
- C - 9" (23cm)
- D - 39" (97cm)
- E - 18" (46cm)

"TRIM" is defined as any combustible
protruding 1/2" or less from the wall.

When installed on a combustible floor,
non-combustible floor protection, with a
R value of 1.0 or greater, is required to
cover the area beneath the heater, 18" in
front of, and 8" beyond both sides of the
glass opening. (See "Top View" diagram)

OPTIONAL KITS:

Mantle Shield Kit	Kit # 94-79700
Screen	Kit # 94-69900
Matte Surround Caps	Kit # 94-5970510
Blue/Black Surround Caps	Kit # 94-5970559
Matte Double Surround Caps	Kit # 94-5970710
Blue/Black Double Surround Caps	Kit # 94-5970759
Surround Extension	Kit # 94-5990010

* Refer to the Installation Manual for
additional clearance information.



**CAUTION: HOT WHILE IN OPERATION. DO NOT TOUCH. KEEP
CHILDREN, CLOTHING AND FURNITURE AWAY. CONTACT MAY
CAUSE SKIN BURNS. SEE NAMEPLATE AND INSTRUCTIONS.
INSPECT AND CLEAN CHIMNEY AND CONNECTOR
FREQUENTLY. UNDER CERTAIN CONDITIONS OF USE,
CREOSOTE BUILDUP MAY OCCUR RAPIDLY.**

U.S. ENVIRONMENTAL PROTECTION AGENCY
Certified to comply with July 1, 1990 particulate emissions standards

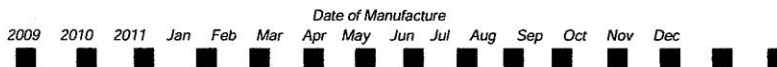

DO NOT REMOVE OR COVER THIS LABEL

3300-717

WARRANTY REGISTRATION

The Original Purchaser can complete their warranty registration on our website at www.hearthstonestoves.com, or send a completed and signed Warranty Registration Form, which is enclosed in the Woodstove warranty packet, to the following address:

Hearthstone Quality Home Heating Products, Inc.
Warranty Department
317 Stafford Avenue
Morrisville, VT 05661

 **NOTE: SENDING IN THE SIGNED WARRANTY REGISTRATION FORM IS *NOT REQUIRED* AS A CONDITION OF WARRANTY COVERAGE OR HEARTHSTONE'S PERFORMANCE.**