

HearthStone

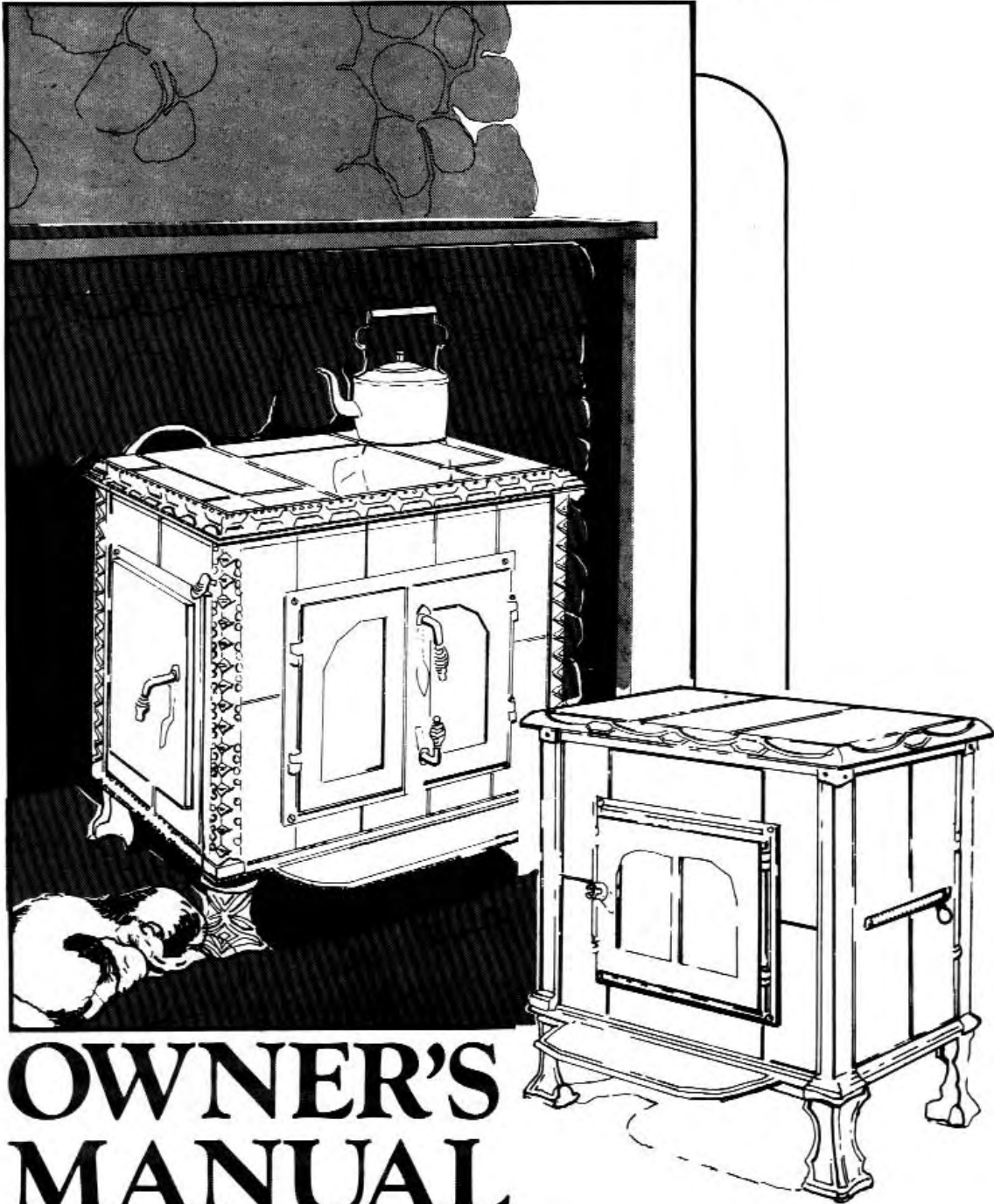

OWNER'S MANUAL

SAFETY NOTICE: IF THIS STOVE IS NOT PROPERLY INSTALLED, A HOUSE FIRE MAY RESULT. FOR YOUR SAFETY, FOLLOW THE INSTALLATION DIRECTIONS. CONTACT LOCAL BUILDING OR FIRE OFFICIALS ABOUT RESTRICTIONS AND INSTALLATION INSPECTION IN YOUR AREA.

PART I: INSTALLATION

Welcome



to the HearthStone Family. You have made an investment in perhaps the finest solid fuel radiant heater available today. To own a HearthStone is to make a statement — a statement of your appreciation and understanding of exceptional quality.

Please read this manual in its entirety. Its purpose is to familiarize you with your stove's safe installation, proper break in, operation, and maintenance. It contains information that will be useful to you now, and in years to come. So keep it handy and refer to it as needed.

The performance of your stove depends on many variables that make your particular installation unique. The sections on operating procedure and general information, therefore, can only serve as useful guidelines rather than hard and fast rules. Moreover, from time to time we make product improvements in between updated press runs of this manual. Should you have any questions, do not hesitate to contact the factory or your dealer for additional information. You have invested in a lifetime product whose warranty is accompanied by a pledge to provide you with assistance as long as you own your stove.

ABOUT YOUR WARRANTY: Your new HearthStone Stove has been inspected at the factory prior to shipment, and determined to be free of defects in materials and workmanship.

Should a problem arise with your stove, you are protected by HearthStone's Limited Warranty, which covers defective stove parts for a period of three years from the date you receive your stove. For more details, please consult the warranty card which you will find in your stove.

Note that door glass, door gaskets and furnace cement are not covered by your warranty, and that the HearthStone Coal Conversion Kit is covered by its own one-year warranty.

Note also that failure to follow installation and basic operation recommendations presented in this manual will void your warranty, as will negligence, abuse, modification to the stove, or overfiring, as determined by HearthStone Corporation or an Authorized HearthStone Dealer.

Lastly, we cannot stress enough the importance of returning to us your Warranty Registration Card, which you will find in your stove. Simply separate it from the portion that states the warranty, which should be kept for your records. Then fill it out and return it to us. This way we will be able to verify and process any warranty claim you may have in the future. In addition, we will have the means to contact you about your stove, should the need ever arise.

SAFETY NOTICE: If this stove is not properly installed, a house fire may result. For your safety, follow the installation directions. Contact local building officials about restrictions and installation inspection in your area.

Researched & Written by John McGinnis
Designed & Illustrated by Judy Fairclough Sgantas
Reviewed & Edited by the entire Hearthstone Staff



TABLE OF CONTENTS

PART I. INSTALLATION 2

- Section A: Location
- Section B: Chimneys
 - 1. How They Work
 - 2. Selection
- Section C: Fireplace Installations
- Section D: Stovepipe
 - 1. Installation
 - 2. Clearances
- Section E: Hearths
 - 1. Hearth Composition
 - 2. Hearth Size
- Section F: Clearances

PART II. OPTIONS 7

PART III. ASSEMBLY 7

- Section A: Thermostat Control

PART IV. OPERATION 8

- Section A: Controls
 - 1. Thermostat Control
 - 2. Primary Air Inlet
 - 3. Secondary Air Inlet
 - 4. Adjustable Damper
 - 5. Quick-start Control
- Section B: Breaking in Your Stove
 - 1. The Reasons for Break-in
 - 2. The First Fires
- Section C: Everyday Use
 - 1. General Guidelines
 - 2. Fireplace Operation
 - 3. Overfiring Caution

PART V: MAINTENANCE 11

- Section A: During the Season
- Section B: At Season's End
- Section C: Stone Finish
- Section D: Castings
- Section E: Glass Doors
 - 1. Cleaning
 - 2. Replacement

- Section F: Stovepipe and Chimney
 - 1. Creosote
 - 2. Inspection
 - 3. Cleaning

PART VI: SAFETY 14

- Section A: General Procedures
- Section B: Emergency Procedures

PART VII: TROUBLESHOOTING 15

- Section A: Smoking
- Section B: Short Burn
- Section C: Insufficient Heat
- Section D: Grey Areas on Stone

PART VIII: FUELWOOD INFORMATION 16

STOVE SPECIFICATIONS

MODEL: Brownstone ____
 HearthStone I ____ HearthStone II ____
 Rear Flue ____ Top Flue ____

SOAPSTONE

FINISH: Unpolished ____ Glazed ____ Polished ____

SERIAL NUMBER: _____

STOVE PURCHASED AT:

 Factory _____ Dealer _____

If Dealer, STORE NAME: _____

 ADDRESS: _____

 PHONE NUMBER: _____

 DATE PURCHASED: _____

GENERAL INFORMATION



317 Stafford Avenue
Morrisville, Vermont 05661

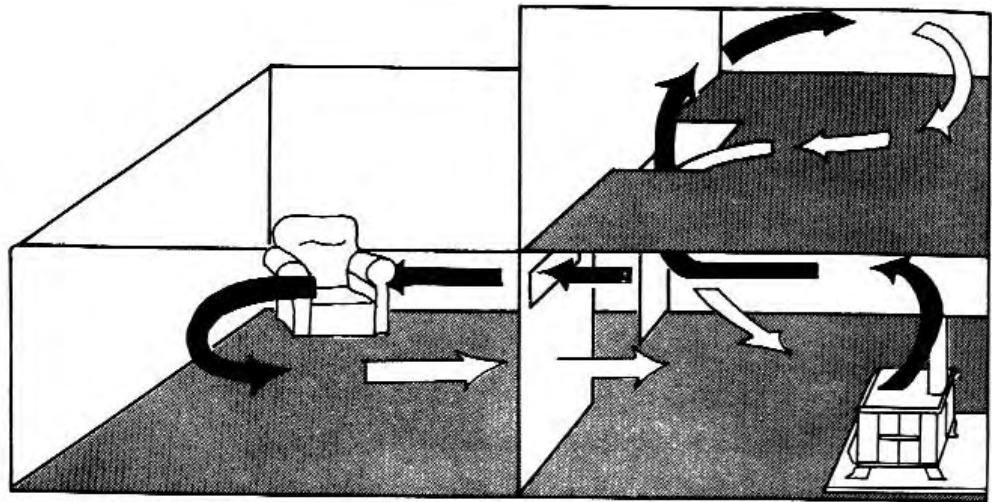

SAFETY NOTICE: IF THIS STOVE IS NOT PROPERLY INSTALLED, A HOUSE FIRE MAY RESULT. FOR YOUR SAFETY, FOLLOW THE INSTALLATION DIRECTIONS. CONTACT LOCAL BUILDING OR FIRE OFFICIALS ABOUT RESTRICTIONS AND INSTALLATION INSPECTION IN YOUR AREA.
PART I: INSTALLATION

SECTION A: LOCATE YOUR STOVE FOR OPTIMUM COMFORT

The useful heat output of your stove is delivered both as infrared radiation and heated air. Radiation directly warms the walls, ceilings, furniture—the masses surrounding your stove. The air coming into contact with the stove and these masses is also heated.

Your HearthStone's soapstone walls produce an incredibly even, gentle, radiant heat that travels naturally to distant rooms—in most cases, no matter where you locate the stove. But by locating the stove centrally and providing for the free flow of heated air, you can maximize uniform comfort throughout your home. While not essential, an open floor plan is ideal because neither radiation nor air flow is inhibited by interior walls. Ceiling-level registers and/or fans can often help dramatically (especially in well-sealed, well-insulated houses) to move warm air that collects at the ceiling into adjacent rooms.

Locating your stove in an uninsulated basement is a great way to heat your basement, but not the rest of your house. The amount of radiant energy required to heat your basement walls is so great that most of the usable heat is absorbed by them and lost. Fans and floor registers will aid in directing warm air where you want it, but generally your HearthStone stove belongs in *your living area*.

SECTION B: CHIMNEYS

Your stove's performance depends on the following:

1. Chimney and installation
2. Operating technique
3. Fuel quality

You can vary the operation of your HearthStone, and over the years you'll probably use wood and/or coal of varying quality. But once your chimney is in place, it's usually there to stay. If you plan to use an existing chimney, the following information will help you determine if it is suitable for your HearthStone. If you intend to build a new chimney, this information will help you make a good choice.

1. HOW CHIMNEYS WORK

A basic understanding of how a chimney works will help you get the most out of your HearthStone. A chimney's function is to:

1. Vent the smoke and gases safely out of your house.
2. Supply the *draft* necessary to pull air into your stove's firebox, which keeps the fire going.

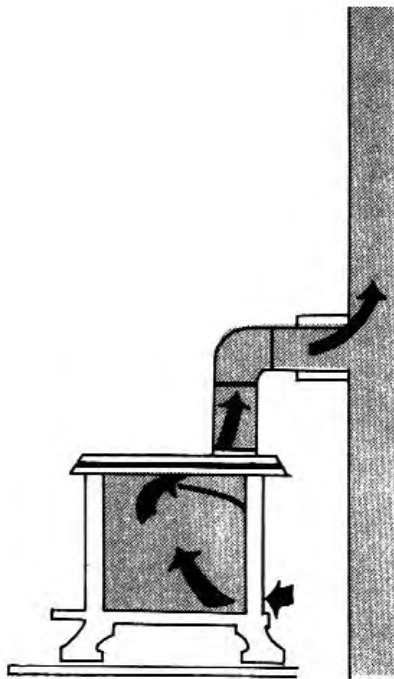

MASONRY CHIMNEYS

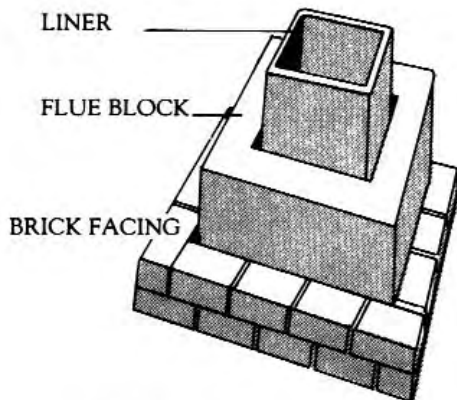

LINER

FLUE BLOCK

BRICK FACING

MASONRY CHIMNEYS

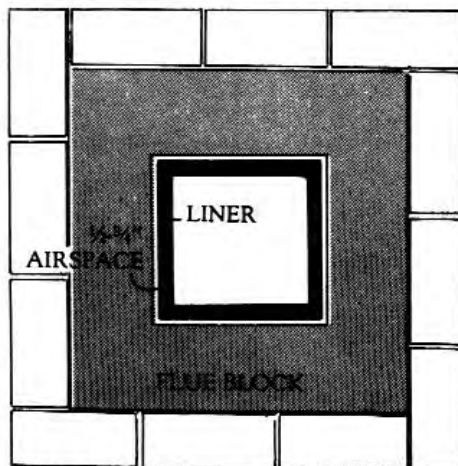

LINER

AIRSPACE

FLUE BLOCK

BRICK FACING

WHAT IS DRAFT?

Buoyancy, or the tendency for hot air to rise, creates draft. As you start a fire in your stove, the hot air rises into your chimney and is vented outside. The chimney gradually becomes hot, and aids in maintaining draft. Often, until the stove and the chimney are heated, draft is not adequate for optimum performance.

The location, size and height of your chimney all affect the draft. Consider the following:

****Chimneys located inside your house stay hotter, so the draft is greater.**

****Properly sized chimneys maintain proper draft and flow (see recommended chimney size, page 4).**

****Chimney height affects draft—the higher the chimney, the stronger the draft. Your chimney should be at least three feet higher than the point where it passes through the roof, or two feet higher than anything within 10 horizontal feet.**

There are many other factors that affect draft, and, therefore, the performance of your stove. For example:

****An "Airtight" House—**If your home is super-insulated or especially well-sealed, an inadequate supply of air entering the stove may cause a weak draft. Ducting in air from the outside to the vicinity of the stove (ideally near the primary air inlet) can correct this problem.

****Tall Trees or Buildings—**Chronic or occasional down-drafts are often a result of nearby trees and buildings dampening the draft from outside.

****Wind Velocity—**Generally, the stronger a steady wind, the stronger the draft. But "gusty" windy conditions may cause down-drafts.

****Outside Temperature—**The colder the outside temperature, the stronger the draft.

****Barometric Pressure—**On balmy, wet or muggy days, draft is generally sluggish.

****Briskness of Fire—**The hotter the fire in your stove, the stronger the draft.

****"Breaks" in the Chimney—**An unsealed cleanout door, leaky stovepipe joints, or another appliance vented into the same flue may cause inadequate draft.

2. SELECTION

If you plan to provide a new chimney for your stove, you have two basic choices:

1. a masonry chimney
2. a pre-fabricated metal chimney

Tests have shown that masonry and metal chimneys of similar size do not vary greatly with respect to draft produced under similar conditions. Your personal taste, house design and budget will dictate which chimney construction you select. Whenever possible, locate the chimney *inside* the house, as it will draw better, accumulate less creosote and last longer.

The advantages of a masonry chimney are:

1. The mass of tile and brick helps to reduce temperature fluctuations in the chimney.
2. The heat-holding characteristics of a masonry chimney can keep a home warm long after the fire is out.
3. It can be custom-made to suit your needs and taste.
4. If properly constructed, it can be far more resistant to chimney fire damage than metal chimneys.

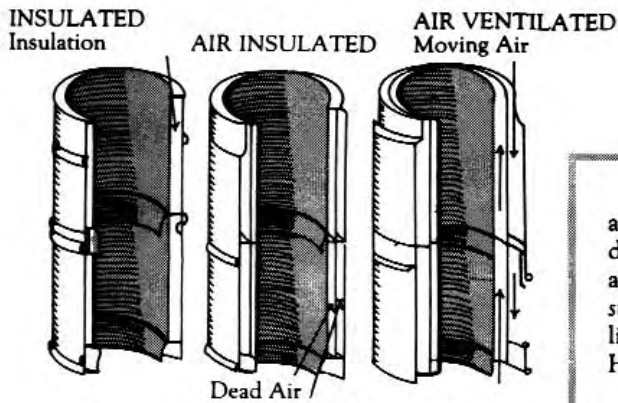

3 PRE-FAB METAL CHIMNEYS FIG. 1

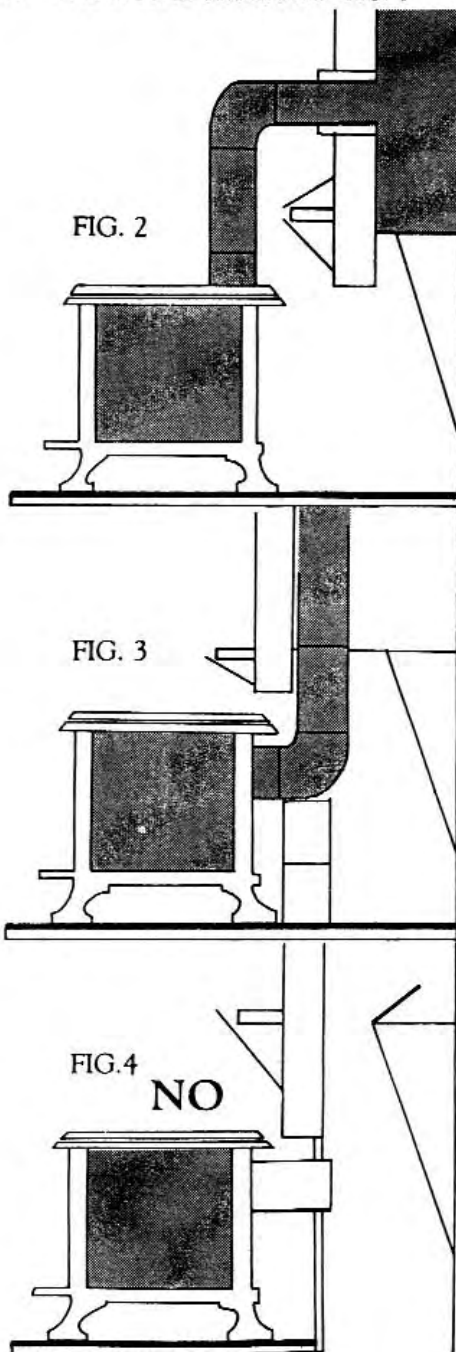

Masonry chimneys should be Class A, and lined. Liners are commonly made of vitreous clay or terracotta and are designed to withstand high temperature and corrosion. They are available in round, square, and rectangular shapes, but the size is most important. We recommend the following standard liners to be used in chimney construction to serve your HearthStone:

- ** **HearthStone I** — 8" inside diameter (round) or standard 8" x 12" (rectangular).
- ** **HearthStone II** — 6" inside diameter (round) or standard 8" x 8" (square).
- ** We do not recommend the use of an unlined chimney.
- ** Nor do we recommend reducing the size of the flue at any point where it will restrict the airflow. For example, do not run an 8" pipe through a 6" thimble.

A simple diagram of a properly constructed masonry chimney designed to serve a HearthStone appears on page 3.

Advantages of a pre-fabricated chimney system are:

1. It is relatively easy to install.
2. You have more flexibility in choosing a location.
3. It can eliminate flow-impeding angles.

Only Class A, all-fuel, factory built chimneys should be used. Three common types of pre-fabricated metal chimneys are shown. The air-ventilated, or thermo-siphon type may produce excessive creosote build-up because the cool air can cause smoke and gases to condense on the inner liner.

SECTION C: FIREPLACE INSTALLATION

Generally, fireplace chimneys, while fully serviceable, are not best for stove installation because many are over-sized and, therefore, promote premature cooling of smoke and gases. Consequently, draft may be reduced and creosote may increase. The best fireplace installation is into an interior fireplace chimney that is lined and in good repair. If the fireplace chimney you wish to use is not in good repair, we recommend lining the chimney with a stainless steel liner of the proper diameter. Figures 2 and 3 illustrate recommended methods of venting your stove into a fireplace chimney. Remember to maintain proper clearances to the fireplace mantel and any other combustible walls or materials (see Part I, Section F.).

Figure 2 allows for the easiest routine inspection and cleaning of your chimney, although it requires the installation of a thimble above the fireplace opening.

In Figure 3, the stovepipe should extend through the smoke chamber and all the way into the liner of the chimney. The damper opening through which the stovepipe passes should be sealed with either a fitted metal plate, or non-combustible fiberglass or rock wool insulation supported with plumber's strapping.

We do not recommend installing your HearthStone as in Figure 4 because the walls of the fireplace opening serve as a huge cooling surface that adversely affects the draft and creosote accumulation.

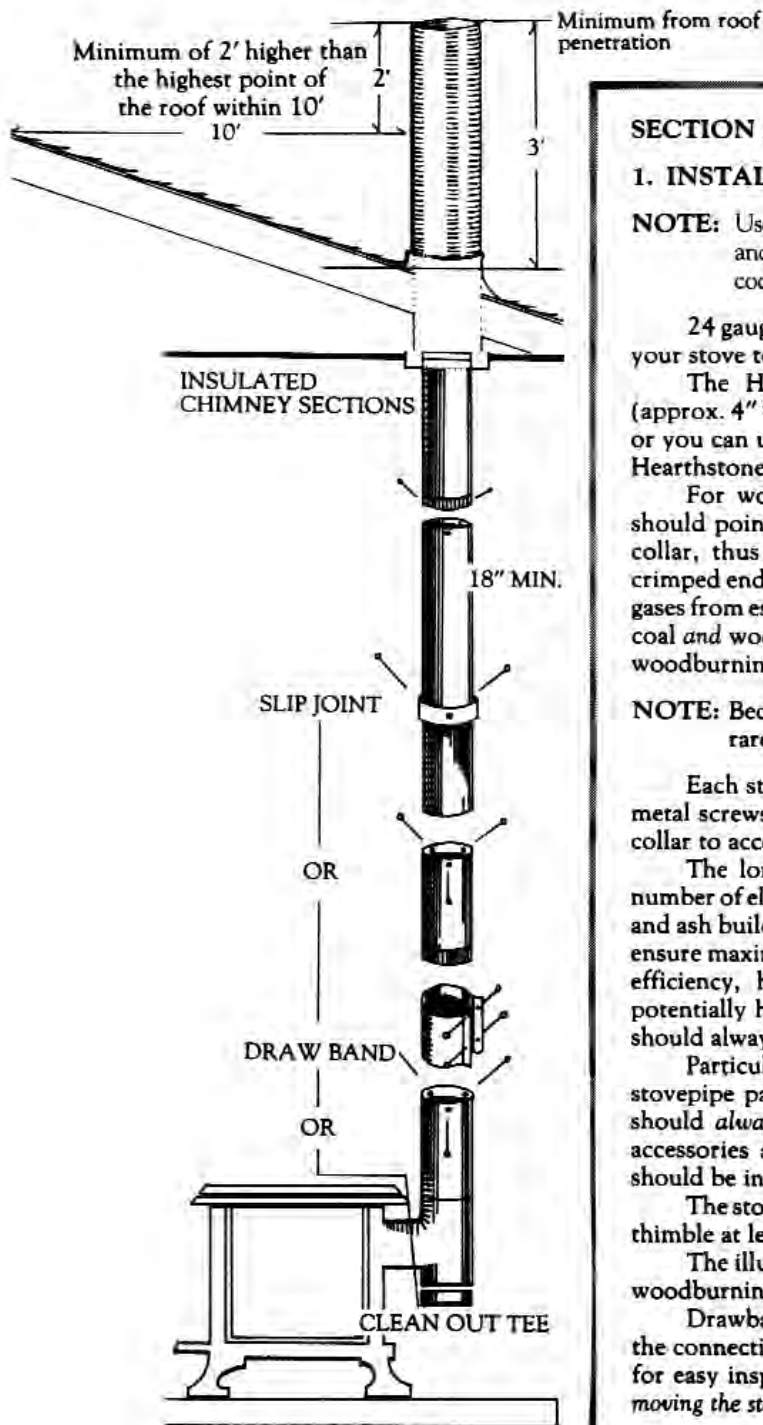
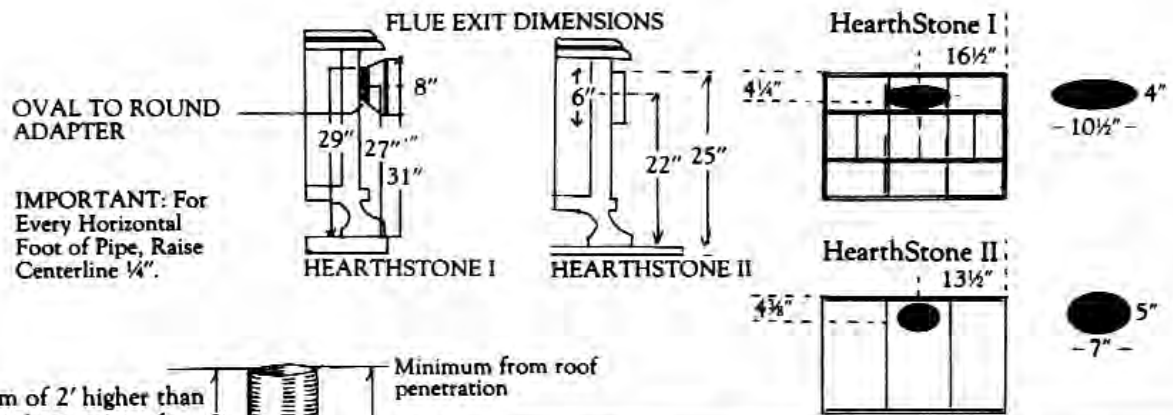

SECTION D: STOVEPIPE

1. INSTALLATION

NOTE: Use of Aluminum Type B gas vent for solid fuels is unsafe, and prohibited by the National Fire Protection Association code.

24 gauge stovepipe (or heavier) must be used to connect your stove to the chimney flue.

The HearthStone I flue collar is ellipsoid in shape (approx. 4" x 10"). An 8" stovepipe can be bent to fit the collar or you can use an oval-to-round pipe adapter, available from Hearthstone. The HearthStone II can accept standard 6" pipe.

For woodburning, the crimped ends of the stovepipe should point down, toward the stove, and fit *inside* the flue collar, thus eliminating creosote leakage. For coalburning, crimped ends should point up, to prevent any of the toxic coal gases from escaping through the joints. If you plan to burn both coal *and* wood, we recommend installing the stovepipe as for woodburning, and seal each joint with furnace cement.

NOTE: Because of the damper in your HearthStone stove, rarely is a stovepipe damper necessary.

Each stovepipe joint should be secured with three sheet metal screws. Holes are pre-drilled in the HearthStone's flue collar to accept the 1/8" x 1/2" sheet metal screws.

The longer the stovepipe length and/or the larger the number of elbows, the greater the chance of dangerous creosote and ash build-up. In the past, installers strove for long runs to ensure maximum heat dispersal. Because of the HearthStone's efficiency, however, this is unnecessary and represents a potentially hazardous situation. Horizontal runs of stovepipe should always rise away from the stove 1/4" per foot.

Particular attention should be paid to the point where the stovepipe passes through a wall or ceiling. This penetration should *always* be made with insulated pipe and the proper accessories and, once made, the remainder of the chimney should be insulated pipe *only*.

The stovepipe should extend into the chimney or chimney thimble at least 2", but not so far as to block air flow.

The illustration shows standard stovepipe assembly for a woodburning installation.

Drawbands, slip-joints and cleanout tees greatly simplify the connection of stove to chimney. Additionally, they allow for easy inspection and dismantling of the stovepipe *without* moving the stove.

2. STOVEPIPE CLEARANCES

Stovepipe must be a minimum of 18" from any combustible surface or material. If shielded stovepipe is used, this clearance may be reduced to 9". However, keep in mind the recommended clearances for your stove, which may determine the overall clearances.

SECTION E: HEARTHES

1. HEARTH COMPOSITION

Local fire safety requirements may vary, but we require a minimum of 4" of masonry (standard brick standing on edge) mortared onto 28-gauge sheet metal which covers a plywood sub-hearth. An acceptable alternative to this composition requires use of the HearthStone Heat Shield, 3/8" asbestos millboard (or equivalent) covered with a non-combustible material of any thickness (tile, slate, etc.). Catalytic models require two sheets of millboard, tile, and a HearthStone Heat Shield.

2. HEARTH SIZE

The hearth should extend beyond the body of the stove by the following dimensions:

	HearthStone I	HearthStone II
Front	18"	18"
Loading Door Side	18"	18"
Opposite Side	12"	12"
Rear	12"	To the wall in back of the stove

HEARTH COMPOSITION

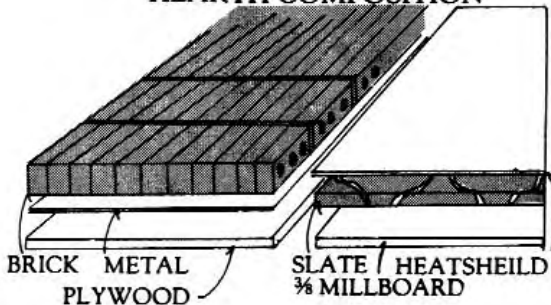

CLEARANCES

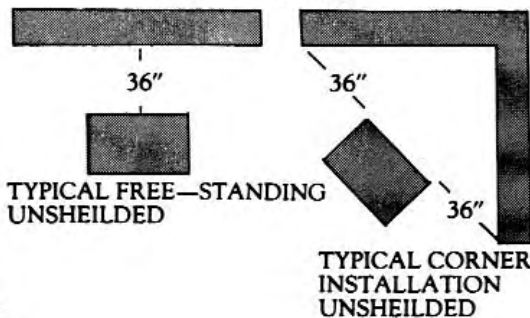

SECTION F: STOVE CLEARANCES

1. COMBUSTIBLE SURFACES

A combustible surface is one that has any combustible components, regardless of its covering. For example, a standard stud wall covered with sheetrock and further covered with brick or brick veneer is still considered a combustible surface. This is because the brick conducts heat very rapidly to the sheetrock and studs.

Without adequate clearances or a HearthStone Heat Shield, the wall materials will dry out over time and their ignition temperatures will be drastically reduced, therefore increasing the chances of spontaneous combustion.

**Note: In some instances, local building codes may supercede HearthStone's requirements.

2. STANDARD MINIMUM CLEARANCES

The following clearances to combustible surfaces are approved by Arnold Greene Testing Laboratories, 6 Huron Drive, Natick, Massachusetts, in accordance with UL standards 737 and 1482:

TYPE OF INSTALLATION		CLEARANCE REQUIREMENTS					
Stove Model	Exit	Rear Heat Shield	Stovepipe	Front	Loading Door Side	Opposite Side	Rear
HearthStone I	top or rear	no	single wall	36"	36"	24"	18" *
HearthStone I	top or rear	yes	double wall, shielded single wall or class A solid insulated	36"	36"	24"	12"
HearthStone II Catalytic II Gemini II	top	no	single wall	36"	36"	22"	26" *
HearthStone II Catalytic II Gemini II	top	yes	double wall, shielded single wall or class A solid insulated	36"	36"	22"	16"
HearthStone II Catalytic II	rear	no	double wall or shielded single wall	36"	36"	22"	26"
HearthStone II Catalytic II	rear	yes	double wall or shielded single wall	36"	36"	22"	20"
HearthStone II Catalytic II	rear	yes	class A solid insulated	36"	36"	22"	12"

* On any unshielded installation HearthStone recommends a 36" clearance to all combustibles.

3. CORNER CLEARANCES

In a corner installation, side clearances to combustibles are 36" on both sides, whether or not the stove has a rear heat shield.

Further Information:

Chimneys, Fireplaces, Vents and Solid Fuel Burning Appliances (National Fire Protection Association, 1984). Write to: NFPA, Battery March Park, Quincy, MA 02269.

PART II. OPTIONS

Some HearthStone Stoves are available with optional Coal Conversion Kit (HearthStone II), optional Hot Water Coil (all models) and optional right-hand door. Note that on HearthStone II right-hand door models, ashpan access is still on the left side of the stove.

Instructions for installation and operation with the Coal Kit or Water Coil will accompany your stove separately if you have ordered it with the option, or come with the units themselves if you have ordered them as retrofits.

Catalytic models are also accompanied with separate instructions.

PART III. ASSEMBLY

Your HearthStone is completely assembled. Once situated on your hearth, all that remains to be accomplished is to connect the stovepipe from stove to chimney, and attach the thermostat control.

Make sure all stovepipe pieces are well-mated and secured with sheet metal screws. (See section on *Stovepipe*.) The entire connection should be very sturdy with little or no "give" or movement. Depending on the quality and fit of your stovepipe, sealing the joints with furnace cement may or may not be advisable to assure air-tight seams.

SECTION A: THERMOSTAT CONTROL ASSEMBLY

1. Identify all parts:
 - a. threaded handle with bi-metallic coil
 - b. connector rod
 - c. stop nuts (2)
 - d. spring
2. Install the parts on the stove:
 - a. Remove the spring from the connector rod and place it into the hole in the casting in the upper right hand corner of the rear of the stove.
 - b. Thread handle into the hole and tighten it. When it is reasonably tight (do not force), position the handle vertically.
 - c. Remove the stop nut from the unbent end of the rod and move that end of the rod up through the bottom of the primary air cover, then up through the hole in the coil.
 - d. Reattach the stop nut above the coil so that the primary air cover is open approximately $\frac{3}{4}$ ".

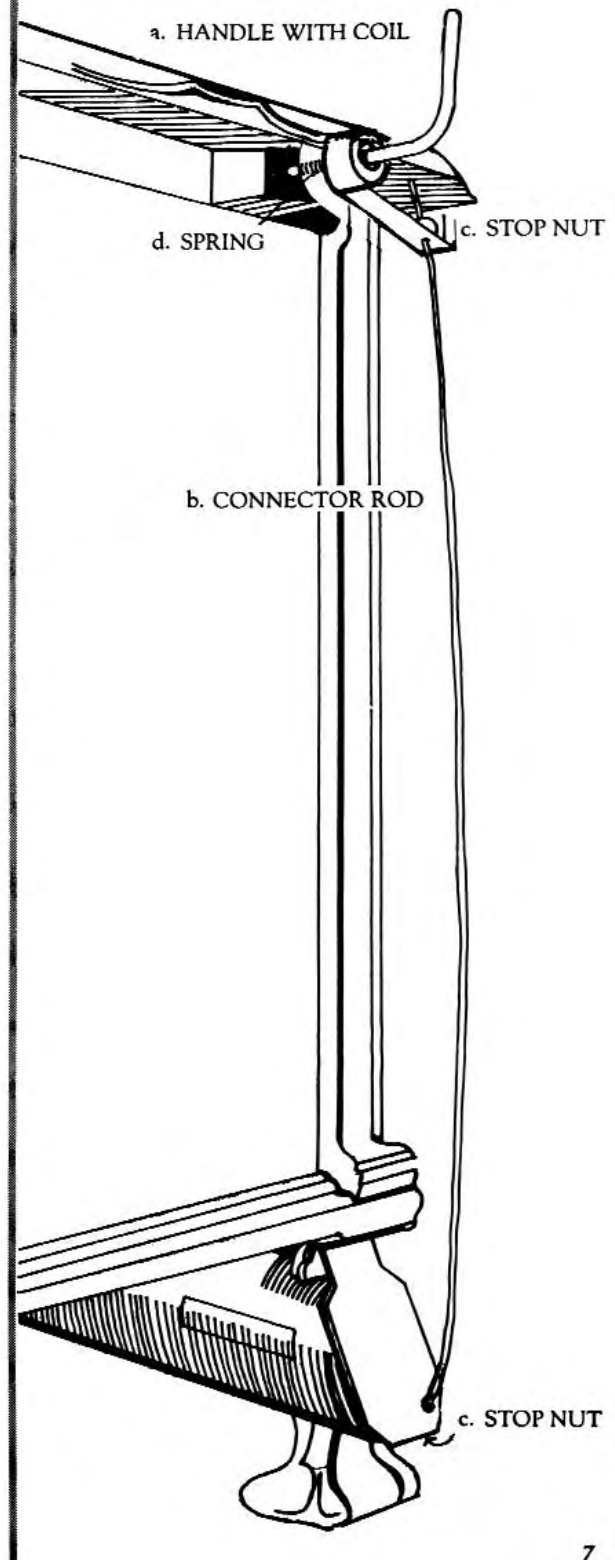

Hearthstone I

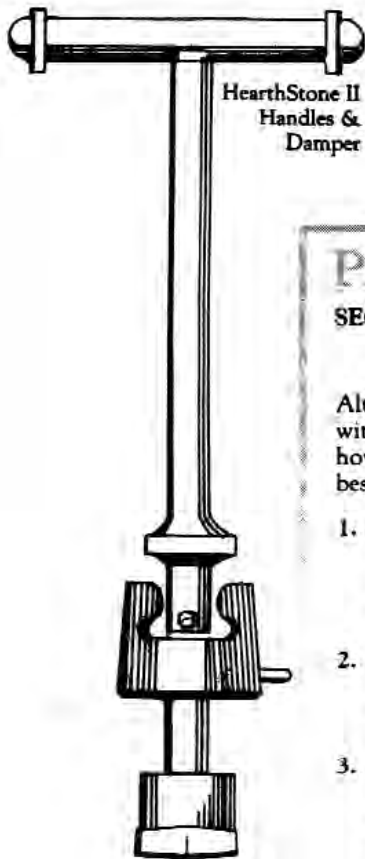

HearthStone II
Handles &
Damper

HearthStone II
Ashpan Door Camlock

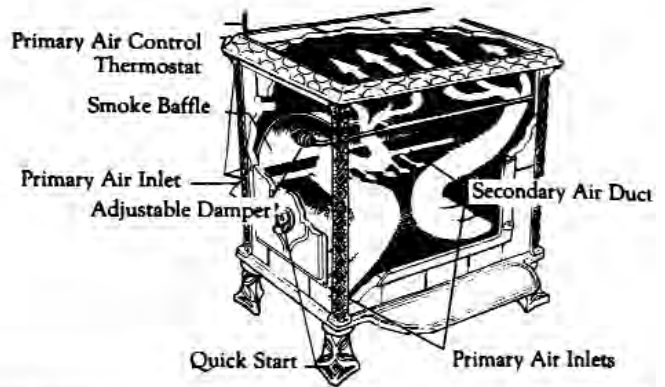
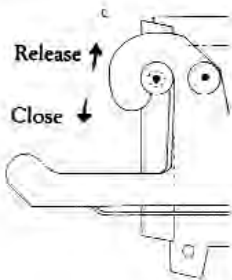

PART IV: OPERATION

SECTION A: THE CONTROLS OF YOUR HEARTHSTONE

Before lighting your first fire, familiarize yourself with the controls of your stove. Although operating your stove is relatively easy, woodburning is a complicated process with a great number of variables, and it takes time and experimentation to understand how these variables interact. With patience, you will learn how to operate your stove to best suit your needs.

1. **The thermostat control** is basically a manual control, with the added convenience of a bi-metallic coil to ensure an even, steady burning cycle. You determine the desired heat output and the duration of the burn by moving the handle to the right or to the left. Once set, the bi-metallic coil serves as a "regulator" — slightly moving the primary air cover up and down to maintain a steady fire.
2. **The primary air inlet** is the opening at the rear of your stove into which air flows to keep the fire going. The amount of air and, therefore, the rate of burn, depends on how wide the primary air cover is open. The wider the cover is open, the faster and hotter the fire will burn.
3. **The secondary air inlet** is located on the right side of the stove. Fresh air is drawn into the secondary air inlet by the draft. It is pulled through the smaller holes inside the firebox creating a "venturi effect." This effect produces a turbulent mixture of the fresh air and the volatile fuel gases directly above the fuelbed. It is at this point that sufficient temperatures are present to allow for effective secondary combustion.

We recommend that the secondary air cover remain open at all times. The cover's primary function is to shut off the air supply in the event of a chimney fire. The space between the secondary air inlet and the cover allows for expansion of the secondary air tube, enabling the cover to swivel up over the opening if the tube is expanded.

The door handles and adjustable damper of the HearthStone II are operated with the removable T-handle. Insert the end of the handle into the control you wish to operate, and turn. The ash pan door of the HearthStone II has a permanently affixed camlock handle; pull up to unlock and open, push down to lock and close.

4. **The adjustable damper** is located just above the front door(s) *inside* the stove. The damper is in either the open or closed position. The position is controlled by the damper control on the upper left side of the stove. Coupled with the curved smoke baffle in your stove, the damper slows the exit of smoke and gases when closed, which allows for maximum heat transfer. When open, the smoke and gases encounter less resistance, and are free to move easily up the stovepipe and into the chimney.

WHEN TO OPEN THE DAMPER:

- ** When starting the stove.
- ** When operating the stove as a fireplace.
- ** For 5-15 minutes after reloading with fuel.
- ** To "boost" the draft as necessary.
- ** Before opening either door to prevent a "backflash."

Hearthstone II

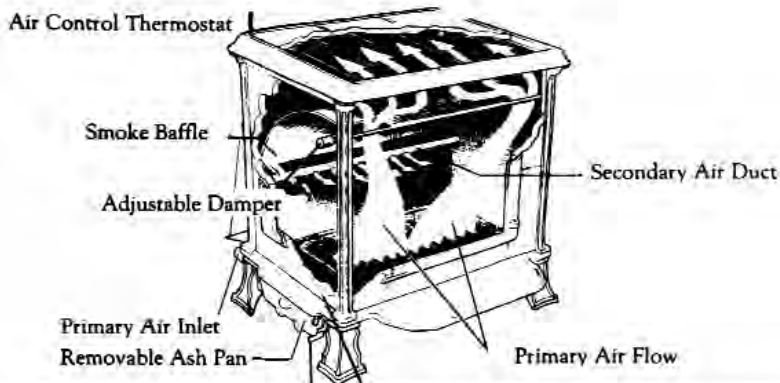

WHEN TO CLOSE THE DAMPER:

** Once the fire in your stove is well established to allow for maximum efficiency and heat transfer.

5. The Quick-Start control is located on the side loading door of the HearthStone I only. Spin the control counter-clockwise to open and admit an extra supply of air to start a new fire quickly or revive dying embers. Close the control by spinning clockwise once the fire is going well.

CAUTION: Operation of your HearthStone with the Quick-Start control open wide for extended periods of time is not recommended. Over-firing is likely to result and may cause a house fire or damage to your stove.

SECTION B: BREAKING IN YOUR STOVE

1. THE REASONS FOR BREAK-IN

It is imperative that your stove be broken in very slowly. There are several reasons why:

1. Cast iron must be "seasoned" . . . over-firing a new stove may cause the bottom casting to crack or damage other stove parts.
2. Moisture in the soapstone must be driven out slowly to minimize the "shock" to the stone of its first exposure to high firebox temperatures.
3. The asbestos-free furnace cement must be cured slowly to ensure adequate sealing and bond.

2. THE FIRST FIRES

Before building the first fire, the bottom casting of your stove must be protected. Please note the separate instructions for the HearthStone I and the HearthStone II.

** **HearthStone I:** Place a layer of common sand or ash in the bottom of the firebox, level with the top of the ridges on the bottom casting. Take care not to obstruct the primary air inlets. Do not use a grate or elevate the fire or over-firing may result. Build the wood fire directly on the stove's bottom. The HearthStone I is not designed or recommended for use with coal—use wood only.

** **HearthStone II:** Place a layer of common sand or ash around the slotted wood grate—not in the ash pan—level with the top of the grate. (Approximately $\frac{3}{4}$ " depth.) Build the wood fire directly on the wood grate. The *HearthStone II* is designed to burn coal only with the *HearthStone Coal Conversion Kit*, which is accompanied by complete instructions for building and maintaining a coal fire.

To build your first fire, place five or six double-sheet, tightly twisted newspaper pieces on the grate or stove bottom. Arrange kindling in a criss-cross pattern over the newspaper—approximately ten pieces, $\frac{1}{2}$ " diameter, 10" to 18" long. Check to make sure the primary air and secondary air covers are open wide, and the adjustable damper is in the open position.

To get the draft started, light a piece of newspaper (hold the tightly-twisted end, light the loose end) and hold it up inside the firebox above the front door. When your chimney begins to draw (you will feel it "grab" the fire at the end of the paper), light the paper under the kindling.

NOTE: You may, at this point, need to open the Quick-Start control of the *HearthStone I*. Over-firing and damage to your stove is likely to occur if this control is left open for extended periods of time.

Under a watchful eye, maintain a steady, low-heat fire. We recommend a stovetop thermometer reading of no more than 150 degrees, (very warm, not hot, to the touch) for your first and subsequent break-in fires. At most, the addition of several small chunks of wood should be all that is necessary to reach these safe break-in temperatures. Once these temperatures are achieved, close all air controls, except for the secondary air cover, and allow the fire to die out completely and the stove to return to room temperature.

We recommend that your first three fires be built and maintained accordingly. Your patience will be rewarded by a properly seasoned *HearthStone*.

NOTE: Because of the cool flue gas temperatures present during break-in, creosote may build up quickly. We recommend a visual inspection (and cleaning, if necessary) of your stovepipe and chimney once the break-in is completed.

SECTION C: EVERYDAY USE

1. GENERAL GUIDELINES

Once properly broken in, your HearthStone is ready for continuous operation. The heat demands of your living area will determine how frequently you will have to load your stove, but, generally, you will probably find it necessary to add a charge of wood two to four times every 24 hours.

If your stove is not to be used continuously, we recommend a relatively slow fire when starting a cold stove. Let all the stove surfaces become uniformly warm before invigorating for a hot fire.

The following is a list of guidelines for in-season, everyday use:

- ** Burn well-seasoned, dry wood — preferably hardwood because of the higher BTU content per pound. (Well-seasoned firewood is that which has been cut, stacked, and covered for a minimum of one year and has a 16% to 20% moisture content.)
- ** For maximum heat output, cut your wood to maximum length — HearthStone I = 24"; HearthStone II = 18". Conversely, the heat output may be lowered by choosing shorter logs and/or logs of smaller diameter.
- ** Reload on a bed of hot, red coals. This practice reduces smoking time and will bring fresh fuel up to high temperature rapidly.
- ** Open your adjustable damper and your primary air control completely for ten to fifteen minutes after reloading.
- ** Avoid "one-stick fires." A good fire requires several logs in close proximity to maintain adequate temperatures for efficient combustion.
- ** Remove ashes as frequently as necessary. Excessive ash build-up will actually reduce the heat output of your stove. The primary air may also be restricted to the point of not providing adequate combustion air, greatly reducing the performance of the stove.
- ** To maintain a proper fire, we suggest the use of a temperature monitor. This will help you operate the stove in a safer, more efficient manner and prevent creosote buildup without overfiring.

NOTE: The proper tool makes all the difference for "tending" of ashes. We recommend a small fireplace hoe. With it, the ashes in the HearthStone I can be pulled away from the air inlets opposite the side loading door, and pushed away from the air inlets closest to the side loading door. Raked across the wood grate of the HearthStone II, fine ash is encouraged to fall through the slots in the grate. If this tool is used and these procedures are followed, the primary air inlets should never become clogged. However, should they become clogged, follow these procedures:

- ** **HearthStone I.** . . . remove ash accumulation as you would ordinarily and make sure that no live embers or coals remain in the stove. Place the suction tool of a vacuum directly up to the air inlets and remove any ash that has accumulated.
- ** **HearthStone II.** . . . make sure the ash pan and ash pan cavity are clean before simply penetrating the slots in the wood grate with a pointed object such as a poker or straightened clothes hanger.

HearthStone II

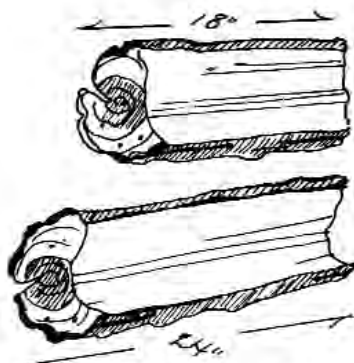

HearthStone I

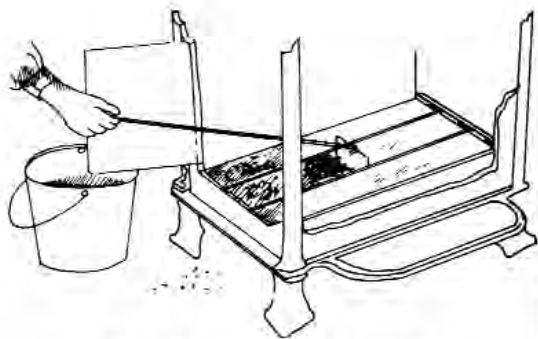

HearthStone I Ash Removal

NOTE: When closing the ash pan door, push the door in all the way before engaging the camlock. Make sure that the door gasket is free of ash so that the door closes without any strain, which will help maintain a tight fit.

CAUTION: In the HearthStone II, ashes should be raked down daily. Excessive ash accumulation raises the level of the coal bed, which may result in damage to the secondary air pipe.

2. FIREPLACE OPERATION

Although the airtight mode provides maximum heating efficiency, there may be times when you will want the warm, cheerful atmosphere that only an open, crackling fire can provide. Also, when operated with the doors open, the HearthStone provides rapid direct heat appreciated chilly mornings. And, while doing this, the HearthStone is still doing what it's designed to do best: storing heat in its soapstone panels.

To Convert to a Fireplace:

1. Open the adjustable damper.
2. Close the primary air control.
3. Open the front door(s), being sure to always insert the safety spark screen to prevent sparks from flying out.

3. OVERFIRING CAUTION

Overfiring means running your stove at excessively high temperatures for extended periods of time. Because it can cause damage to the stove, it should be carefully prevented.

Overfiring is a result of excess draft, which may be caused by the following: leaving the quick-start control, side door or ash pan door open for extended periods of time; venting your stove into an over-sized chimney (see p. 2 section B); lack of proper maintenance procedure which may result in air leakage (see part V); or burning kiln-dried lumber, kindling or any extremely dry fuel, for anything other than fire-starting, which will produce excessively high temperatures. Examples of the damage caused by overfiring are: blistering or bubbling of porcelainized surfaces; warpage and/or failure of the secondary airpipe and warpage of the internal firebox components. ANY OF THE SYMPTOMS OF OVERFIRING WILL VOID YOUR WARRANTY.

PART V: MAINTENANCE

Your HearthStone stove is an appliance that is subjected to temperature extremes and the corrosive residues of burning wood and coal for long periods of time. Periodic maintenance is essential to keep your stove performing as it should. All parts and special maintenance kits are available through HearthStone or your local dealer. (See the Accessories Catalogue.)

SECTION A: DURING THE HEATING SEASON

Everyday: Check ash accumulation and remove ashes, if necessary.

Every Two Weeks: Visually inspect stovepipe and chimney for creosote accumulation. (See Section F.)

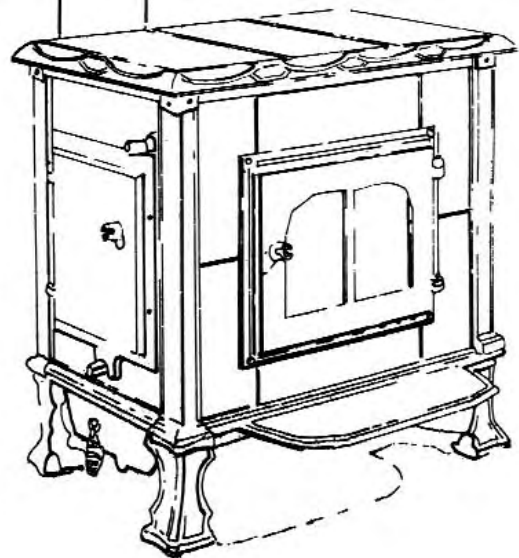

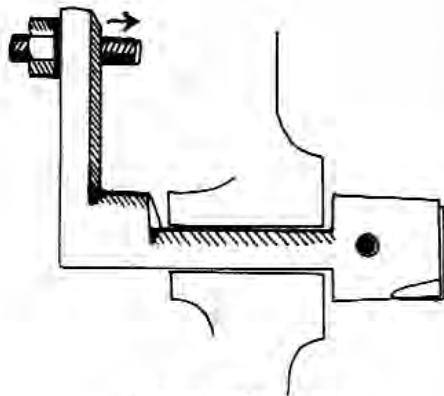

Tightening Door Latch

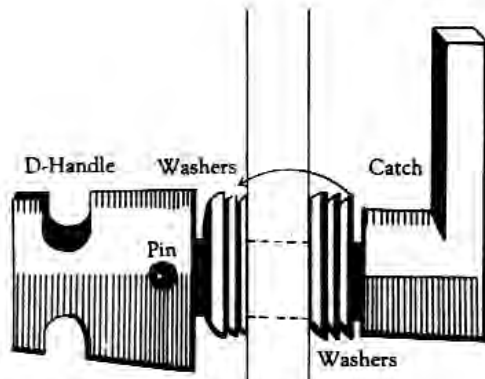

Tightening Side Door
HearthStone II

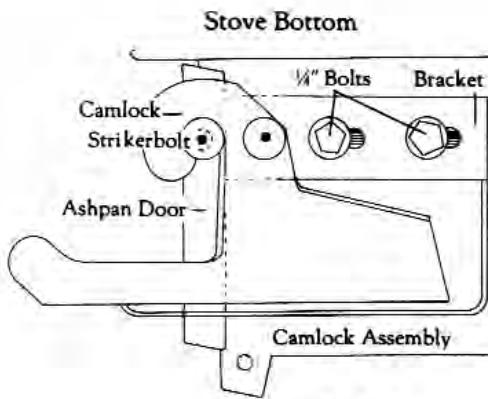

Adjusting Camlock
HearthStone II
Ashpan Door

Every Eight Weeks:

1. Check tightness of the door frame bolts. Snug, if necessary. **Do not over-tighten.**
2. Inspect furnace cement seals between door frames and soapstone on the inside of the stove. Recement, if necessary.
3. Check door-to-door frame seals by closing the door on a dollar bill when the fire is out. If the dollar bill pulls out easily:
 - Tighten the fit of the front door of either the HearthStone I or the HearthStone II or the side door of the HearthStone I, by adjusting the set screw on the handle latch. (See illustration.)
 - Tighten the fit of the side door on the HearthStone II by removing a washer from the inside of the handle and replacing it on the outside of the handle. To do this, tap the pin out of the handle assembly with a $\frac{3}{16}$ " pin punch or a blunt nail. Remove the slotted D-handle and washers and then pull out the catch. Move one of the washers from the catch side to the D-handle side. Replace the catch, washers and D-handle and drive in the pin with a hammer. If this does not sufficiently tighten the door seal, then replace the door gasket. (See illustration.)
4. Check the fit of the HearthStone II ashpan door. To adjust the camlock, follow this procedure:
 1. Using a $\frac{7}{16}$ " wrench, loosen the two $\frac{1}{4}$ " bolts which attach the camlock bracket to the ash pan door. Do not remove the bolts.
 2. With the camlock released, hold the ash pan door firmly closed. Slide the full camlock assembly toward the opposite side of the stove, so that the camlock is just able to engage the striker bolt on the ash pan door.
 3. Hold the assembly in this position while tightening the $\frac{1}{2}$ " bracket bolts. (See illustration.)
5. Check the ash pan door gasket for any ash buildup and remove excess with a vacuum cleaner.

SECTION B: AT SEASON'S END

1. Dismantle stovepipe and clean thoroughly. Replace any pieces that show signs of rust or deterioration.
2. Inspect and clean your chimney, if necessary (See Section F.).
3. Thoroughly vacuum out the inside of your stove. Inspect interior for any signs of damage or deterioration.

NOTE: Soot and creosote that collects on the walls of your stove will dramatically reduce heat output, as will ashes that accumulate *behind* the cast iron plates inside the firebox. You may find it necessary to remove these plates to gain access for cleaning. With a flashlight, also inspect the top of the curved smoke baffle for accumulation of soot and fly ash. A flexible hose attachment to a vacuum will effectively remove these deposits.

4. Inspect gasket material in all doors and replace if worn, frayed, cracked, or extremely hard. Normally, gasket material should be replaced every two to three seasons.
5. Repaint castings, if necessary.
6. Follow instructions for inspection. (See **Every Eight Weeks**, above).

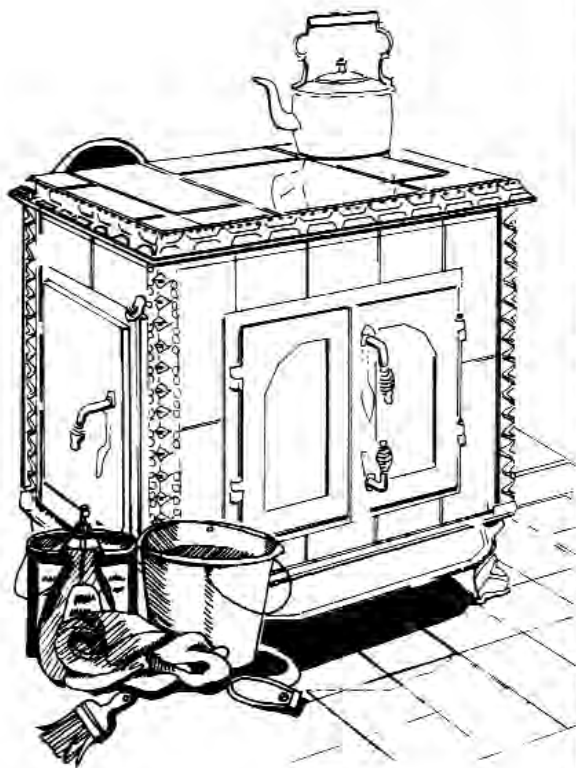

SECTION C: STONE FINISH

Often, subtle earth tones of brown, red and yellow appear in the soapstone with use. This is a natural reaction of the soapstone and cannot be controlled. If your stove is a Brownstone, you may, under very close inspection, find an occasional fine surface crack in the stone. Such a hairline crack is just on the stone surface, and does not affect the integrity of the stone in any way.

Occasional cleaning and/or polishing is all that should be necessary to keep your HearthStone looking beautiful. Care must be taken, however, to prevent scratching or chipping the stone. Brief instructions follow for general care of the soapstone.

- ** **Natural Grey Soapstone:** Any surface scratches or discoloration can be removed by lightly sanding with fine sandpaper (200-220 grit). Stains may need a sprinkle of cornstarch before sanding. Wipe the stone with a clean cloth after sanding to remove any dust. Never use water or a liquid cleaner on unglazed soapstone.
- ** **Glazed Soapstone:** (older models) Occasional cleaning with a cloth and glass cleaner will keep the glazed stone clean and shiny. Any surface scratches or discoloration can be repaired with the glazing kit. (See Accessories Catalogue.)
- ** **Polished Soapstone and Brownstone:** As with fine furniture, you may wish to polish the stone periodically to renew the original lustre and depth of color. We recommend silicon spray. Apply it to the stove when the fire is out, and the stone is just warm to the touch, or cooler.

Spray the stone, let dry and wipe to remove excess and bring up the polish. How long fresh polish lasts will depend on stove use and/or atmospheric conditions.

SECTION D: CASTINGS

All of the HearthStone's cast-iron pieces are treated with a special high temperature paint. A damp sponge will do a fine job of cleaning them. Small cans of the paint are available for touch-up at the end of the heating season. (See Accessories Catalogue.) The porcelainized enamel castings of the Brownstone model can be cleaned with a standard glass cleaner. With time and use, a very fine subtle network of craze lines will appear seemingly beneath the surface. Crazeing is a natural, predictable process and does not represent a flaw in the castings.

However, overfiring will severely damage the porcelainized finish. Evidence of overfiring is a blistering or bubbling of the porcelainized door or castings. This is caused by temperatures in excess of 1600°F. If this should happen, the repairs will not be covered by your warranty.

SECTION E: GLASS

1. Cleaning

The most effective method of keeping the glass clean is to carefully place burning logs toward the front of the stove. Generally a hot fire will burn off most of the soot. For heavier deposits, a razor window scraper will quickly and easily remove the residue. However, be sure to change the blade after each cleaning to prevent scratching the glass. Commercial glass cleaners are also effective.

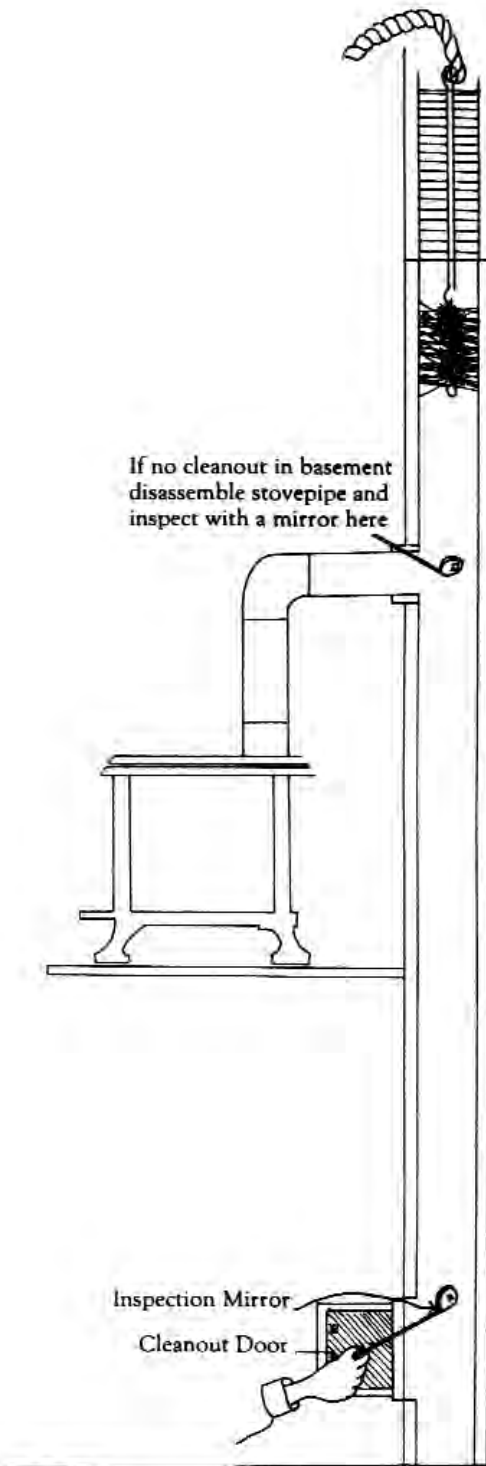

If no cleanout in basement disassemble stovepipe and inspect with a mirror here

Inspection Mirror

Cleanout Door

Chimney Inspection and Cleaning

Never attempt to clean the glass while a fire is in the unit. We recommend removing the door(s) and cleaning it elsewhere if the fire is going. Be sure to place the protective spark screen in the opening before removing the door(s).

NOTE: If windows are consistently sooted, the fire is too cool and rapid creosote buildup may be occurring in the stovepipe and chimney. Inspect and clean as necessary.

2. Glass Replacement

The glass in your HearthStone is a thermal-shock resistant glass made specifically for wood and coal stoves, and should not be substituted. In the event of breakage, it should be replaced immediately. Contact Hearthstone Customer Service Department (See General Information pg. 1) for replacement glass which will be accompanied by complete instructions for removal of cracked or broken glass and proper replacement of the new glass and gasket material.

SECTION F: STOVEPIPE AND CHIMNEY

1. Creosote Formation and Need for Removal

When wood burns slowly, it produces tar and other organic vapors which combine with moisture to form creosote. The creosote vapors can condense in the relatively cool chimney flue of a slow-burning fire. As a result, creosote residue accumulates on the flue lining. When ignited, this creosote makes an extremely hot fire. Any accumulation of $\frac{1}{8}$ " or more should be removed immediately.

Because of the many variables that affect how quickly or how much creosote accumulates, it's impossible to state how often it is really necessary to clean your stovepipe and chimney. *Visual* inspection is the only way to tell, so we highly recommend that you install your stove so that inspection and periodic cleaning is as easy as possible. A clean stovepipe and chimney go hand-in-hand with the woodburner's peace of mind.

2. Inspection

Cleanout tees, slip-joints, and drawbands (See Part I, Section D) are stovepipe component pieces that make both inspection and cleaning very simple. The cleanout tee is most desirable in "straight-up" installations where it is possible to brush the chimney without dismantling any of the stovepipe. The slip-joint and/or drawband are most useful when the stovepipe configuration requires that the pieces be dismantled for cleaning outdoors. A small mirror attached at an angle to a long handle allows for easy inspection through a cleanout tee, once the drawband has been removed, or the slip-joint has been dropped.

When inspecting a masonry chimney, the cleanout door is the place to start, normally found either outside or in the basement at the base of the chimney. The long-handled mirror is once again the best tool for inspection. If your chimney was not constructed with a cleanout door, it must be inspected by either looking directly up through the damper of the fireplace, or through a thimble with the mirror. At times, inspection from the top of the chimney is the only practical method.

3. Cleaning

We do not recommend the use of chemical compounds, salt, or any other material designed to reduce or eliminate creosote. The only effective method of cleaning your stovepipe and chimney is by brushing with properly sized brushes. Most professional chimney sweeps use wire brushes that are available in most every size imaginable. The brushes should fit snugly inside the chimney and/or stovepipe and clean with an up and down motion. Flexible, fiberglass rods are available to attach to the brushes to simplify the cleaning process. The interior dimensions or diameter of your chimney liner should be accurately measured before purchasing a chimney brush cleaning kit. (See Accessories Catalogue.)

PART VI: SAFETY

SECTION A: GENERAL PROCEDURES

There are certain risks that are taken when using a solid fuel heater — be it HearthStone, or any other stove. These risks can be minimized, however, if proper installation and sensible operating procedures, as outlined in this manual, are followed. Additionally, we urge you to use common sense! The following is a list of safety precautions:

1. Always keep combustible items (furniture, drapes, curtains, clothing, etc.) a minimum of 36" from the stove.
2. Do not over-fire your stove! If the stovepipe and castings of the stove begin to creak, change color, or the porcelainized castings begin to blister, you are over-firing.
3. Install a smoke alarm.
4. Keep a fire extinguisher handy. We recommend the type rated A,B,C.
5. Ashes should be placed in a metal container with a tight fitting lid. The closed container of ashes should be removed from the house immediately. If the ashes are disposed of by burial in soil or otherwise locally dispersed, they should be retained in the closed container until all cinders have thoroughly cooled.
6. Never use gasoline-type lantern fuel, kerosene, charcoal lighter fluid or similar liquids to start or "freshen-up" a fire. Keep all such liquids well away from the stove while it is in use.
7. Keep children and pets away from the stove.
8. Inspect your stovepipe and chimney frequently for creosote accumulation and clean, if necessary.
9. Never put articles of clothing or candles on a hot stove.

SECTION B: EMERGENCY PROCEDURES

In the Event of a Stovepipe or Chimney Fire:

1. Close *completely* all air inlets.
2. If a damper is installed in the stovepipe, close it gradually.
3. Call the Fire Department.
4. Keep an eye on the stove, stovepipe, and chimney.

Once the fire has expired, continue to keep all air inlets closed and let the fire in the stove die completely out. *The stove should not be fired again until the stove, stovepipe and chimney are all thoroughly inspected for any sign of damage. Damage should be corrected immediately.*

PART VII: TROUBLESHOOTING

The following is a list of problems that are common to virtually all wood/coal stoves at one time or another. All of the problems are correctable, and, often times, require only a minor adjustment of the stove or operating technique. Remember that the weather conditions drastically affect stove performance. . . most problems caused by the changing weather will be very temporary.

SECTION A: SMOKING

If your stove smokes when you open the loading door or front door(s), it is most assuredly caused by insufficient draft. First, inspect your stovepipe and chimney for creosote accumulation and clean, if necessary. If the insufficient draft is caused by an undersized or oversized chimney (See Part I, Section 2.), a draft inducer or raising the height of the chimney may be the only permanent cure. Smoking may also be the result of restricted or reduced airflow in the stovepipe. (See p. 4). If the outside temperature is mild, try opening the primary air inlet and damper wide for several minutes *before* opening the doors. This will invigorate the fire and heat up the chimney, thereby creating a stronger draft. If your stove *consistently* smokes and is vented into a proper chimney, open a window. If this corrects the problem, it's an indication that your house is tight enough that a supply of outside air may be necessary.

SECTION B: SHORT BURN

Maximum burn time is achieved when the fuel used is hardwood *cut to the maximum length*. Burning softwoods, and burning pieces of wood that are either small in diameter or short in length, contribute to short burn time.

Make sure that you are *closing* the adjustable damper and the thermostat control after the charge of fuel is well-ignited. You may find it helpful to leave 1/2" of the brass linkage rod extending *below* the primary air cover, so that the bi-metallic coil will not prematurely lift the cover and admit additional air.

Short burn time may indicate leakage somewhere in the stove. Visually inspect the gasket on all of the doors for the tell-tale indentation from the door frame. If the door frame is not snugly fitting against the gasket material, adjust the tension with the set screw on the door handle. Check the cover of your primary inlet. . . it may not be sitting flat against the cast iron opening. With a candle, *and while the stove is burning briskly*, check for any leakage where the soapstone meets the cast iron framework and door frames. If any leakage is found, (leaks will suck the candle flame in the stove) an application of a small quantity of furnace cement should correct the problem.

Although rarely needed, either a barometric damper or a stovepipe damper may be advisable for installations with excessive draft.

SECTION C: INSUFFICIENT HEAT

If your stove is not producing adequate heat, monitor the surface temperature. If you consistently achieve a 450+ F degree surface temperature on the stove, it is performing adequately. Check the cleanout door of your chimney for a tight seal. If another appliance is vented into the same chimney, make sure all the air inlets of that appliance are completely closed.

If the stove appears to be producing *less* heat than the previous season(s), a build-up of soot and ash may be preventing adequate heat transfer. (See Part IV, Section 2.).

Green wood and wet wood *drastically* reduce heat output in addition to increasing the likelihood of creosote production. An occasional piece of green (unseasoned, not wet) wood mixed with seasoned woods will promote a longer burn, but it should not be used exclusively.

We also recommend monitoring the stack temperature, making sure that it is consistently between 250^o and 450^oF.

SECTION D: WHITE OR GREY AREAS AROUND DOOR FRAMES (GLAZED MODELS ONLY)

These are not signs of leakage, but of glaze burning off the stove. This is natural and is easily corrected. Simply contact HearthStone's Customer Service Department and order the special glazing compound that will bring the shine back to your stove.

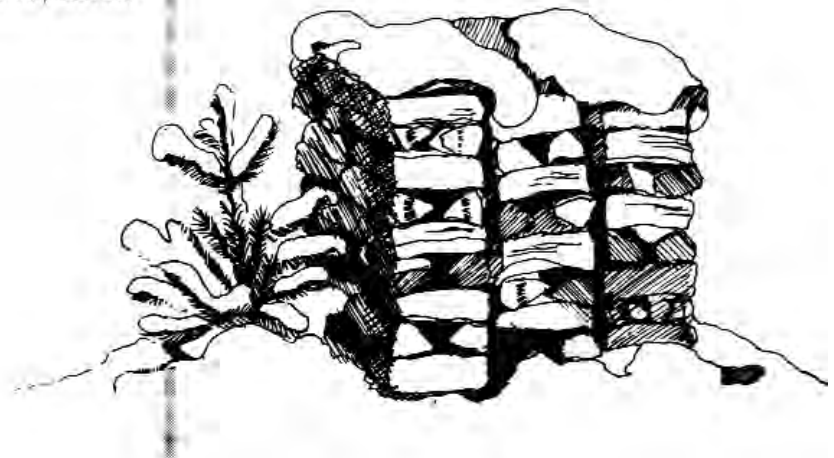

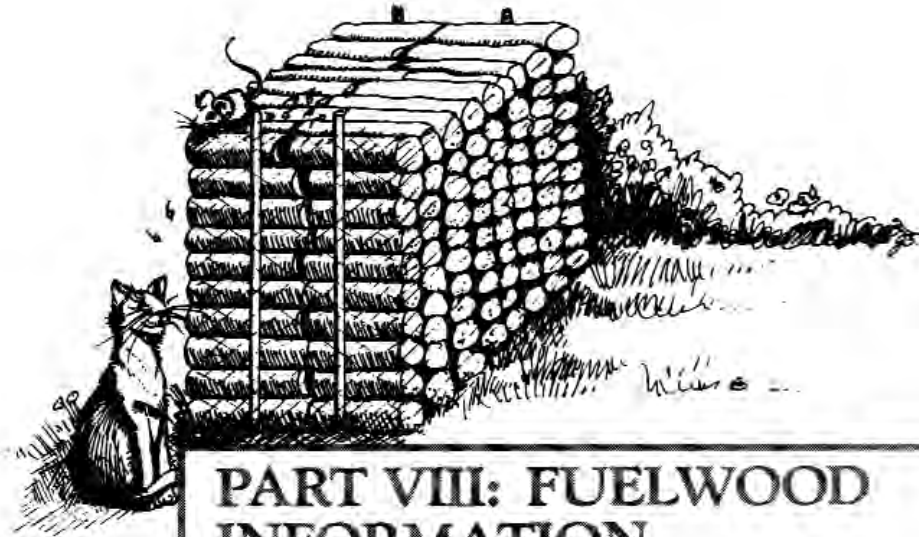

PART VIII: FUELWOOD INFORMATION

The quality of your fuelwood is an important variable which determines both heat output and duration of burn. Softwoods generally burn hotter and faster, while hardwoods burn longer and produce more coals. The *density* of the wood is the critical factor to consider when either purchasing wood or assessing your stove's performance. For your reference, we have provided a list of wood species and their relative BTU content.

High: Ash, Black Birch, Hickory, Hophornbeam, Locust, White Oak, Black Beech

Medium High: White Ash, Beech, Yellow Birch, Sugar Maple, Red Oak

Medium Low: Black Ash, White Birch, Grey Birch, Elm, Norway Pine, Pitch Pine, Black Cherry, Soft Maple, Tamarack

Low: White Pine, White Cedar, Balsam Fir, Spruce, Aspen, Basswood, Butternut, Hemlock

Moisture content also plays a key role in the performance of your stove. Wood that is freshly cut from a living tree (green wood) has a great deal of moisture in it. To properly season green wood, it should be split and stacked and allowed to air dry for a period of six months to one year. Ideally, it should be stacked on skids or blocks to keep it off the ground, and only the top should be covered. (Plastic or tarps that cover the *sides* of the woodpile trap moisture and prevent the wood from drying.) As for stacking, an old Vermonter said: "The spaces between the logs should be large enough for a mouse to get through, but not for the cat that's chasing it."

IN CLOSING. . .

With proper use and care, your new HearthStone will serve you faithfully for years and years to come. We recommend that you keep this manual in a safe and convenient place and refer to it whenever a question arises.

Thank you for choosing HearthStone. We trust that you will enjoy your stove.

HEARTHSTONE SPECIFICATIONS

	HearthStone I	HearthStone II
Maximum Heat Output	100,000 BTU'S/hr. (1)	44,000 BTU's/hr. (1)
Heat Life™ (2)	Up to 18 hours (2)	10 hours with wood, up to 12 hours with coal (2)
Maximum Combustion Efficiency	86% (1)	86% (1)
Size of Heated Area	Up to 24,000 cu. ft.	Up to 10,000 cu. ft.
Fuel Load	4.5 cu. ft. wood	2 cu. ft. wood/30 lbs. coal
Fuel Size	24"-26" logs	18"-20" logs/pea size coal
Maximum Rate of Burn	14 lbs./hr.	10.5 lbs./hr. (wood), 3.51 lbs./hr. (coal)
Minimum Rate of Burn	6.5 lbs./hr.	2-9 lbs./hr. (wood), 1.5 lbs./hr. (coal)
Height	32"	27"
Width	33"	27"
Depth	28"	21"
Fireplace Door (front)	13 ³ / ₄ "H × 17 ¹ / ₂ "W	9 ¹ / ₂ "H × 12 ¹ / ₄ "W
Loading Door (side)	13 ³ / ₈ "H × 11 ¹ / ₄ "W	9 ¹ / ₄ "H × 8 ³ / ₈ "W
Stovepipe Size	8"	6"
— Metal Chimneys	8" inside diameter	6" inside diameter
— Masonry Chimneys	8" × 12" or 8"ins. dia.	8" × 8" or 6"ins. dia.
Flue Exit	Top or Rear	Top or Rear
Rear Flue Exit, center line	27"	22"
Primary Air Control	Thermostat (bi-metallic coil)	Thermostat (bi-metallic coil)
Secondary Air Supply	Venturi System	Venturi System
Actual Weight	729 lbs.	470 lbs.
Shipping Weight	700 lbs.	530 lbs.
Crated Dimensions	38"L × 32"W × 42"H	34"L × 30"W × 39"H
Wood Grate	n/a	Standard Equipment
Coal Grate/Basket	n/a	Optional Equipment
Soapstone Finish	Polished, Polished Brown, Natural Buff Grey	Polished, Polished Brown, Natural Buff Grey
Castings	Matte Black or Brown Porcelainized Enamel	Matte Black or Brown Porcelainized Enamel

(1) Estimate based on latest HearthStone II Independent Laboratory combustion efficiency test results.

(2) Heat-Life is a trademark of HearthStone, Inc., and is defined as thermal capacitance, or the quantity of heat stored. Used here, it refers to hours of useable heat obtainable from a single load of fuel. Area heated and duration of burn may vary from installation to installation.



317 Stafford Avenue
Morrisville, Vermont 05661

HearthStone H-1 Parts

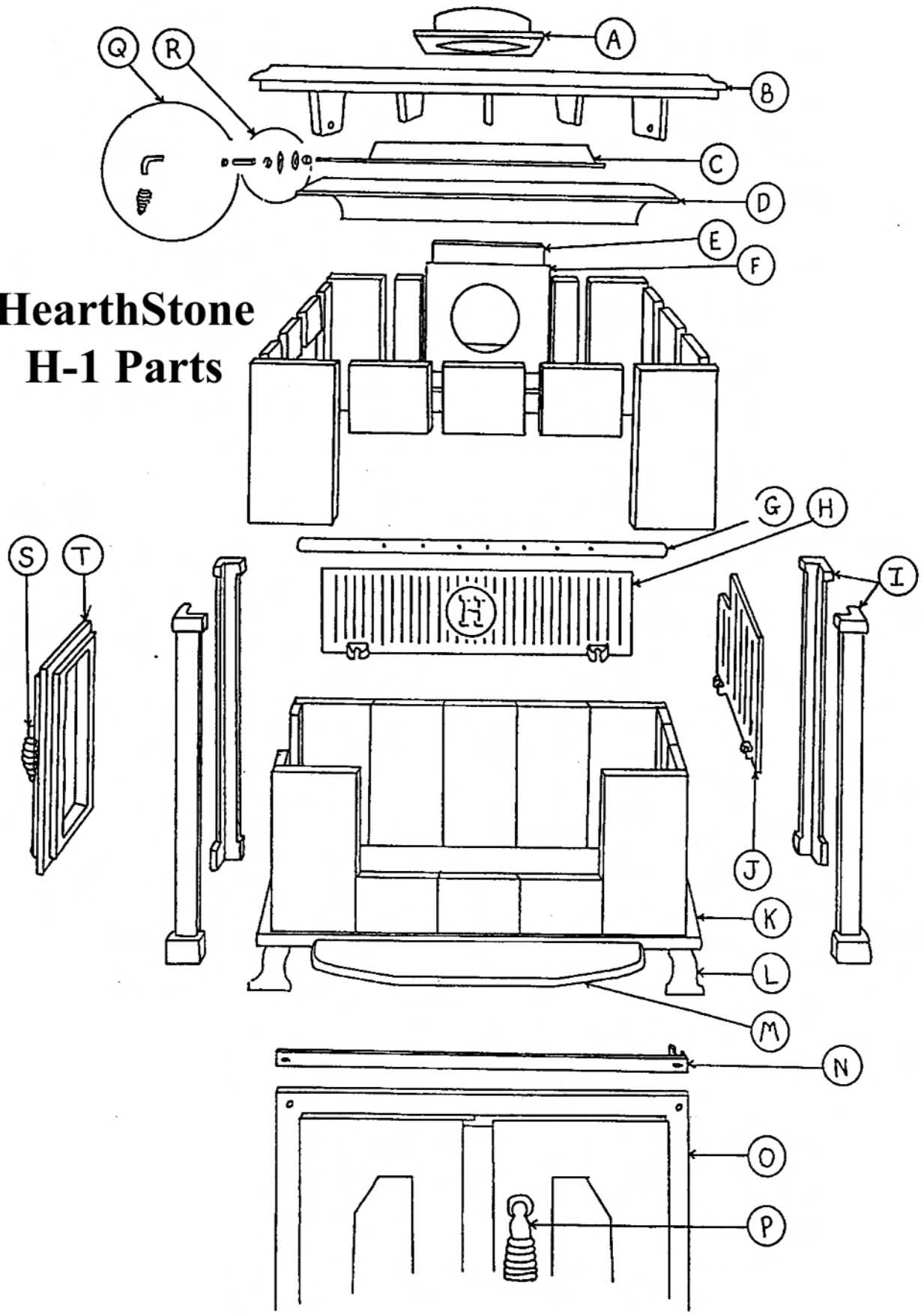

HearthStone

H-I Replacement Parts

REF	DESCRIPTION	ITEM #
A	REVERSIBLE FLUE: ROUND	2111-114A
A	FLUE COLLAR: OVAL	2111-17
B	TOP	2111-01
C	DAMPER: PRE MID-82	91-85131
C	DAMPER: BUILT AFTER MID-82	91-58130
D	BAFFLE	91-58142
E	REVERSIBLE FLUE COVER PLATE	2111-115
F	INNER REAR FLUE PLATE:ROUND	2111-18
F	INNER REAR FLUE PLATE: OVAL	2111-18A
G	SECONDARY AIR PIPE	91-58146
H	BACK PLATE	91-58140
I	SIDE LEG	2111-19
J	SIDE PLATE	91-58141
K	BOTTOM	91-58148
L	FOOT	2111-22
M	ASH LIP	2111-02A
N	SIDE DOOR STEEL	5000-033
N	TOP FRONT DOOR STEEL	91-58150
N	BOTTOM FRONT DOOR STEEL	5000-037A
O	FRONT DOOR AND FRAME	91-58170
P	FRONT DOOR LATCH: BOTTOM DOES NOT INCLUDE COIL	91-58122
P	FRONT DOOR LATCH:TOP DOES NOT INCLUDE COIL	91-58121
Q	DAMPER HANDLE EXTENSION	91-58123
R	DAMPER BUSHING ASSEM	90-58000
S	SIDE DOOR LATCH DOES NOT INCLUDE-COIL	91-58120
T	SIDE DOOR AND FRAME	91-58176
MISCELLANEOUS:		
	GASKET KIT: DOORS AND GLASS	91-58101
	GLASS: 6" X 12"	91-58105
	OVAL TO ROUND ADAPTOR	91-55809
	SPARKSCREEN	91-57100
	BOTTOM HEAT SHIELD	91-57101
	REAR HEAT SHIELD	91-57105
	SPIN-DRAFT RETRO-FIT KIT	91-57110
	FRONT AIR CHANNEL	2111-05
	LEFT AIR CHANNEL	2111-06
	RIGHT AIR CHANNEL	2111-07
	UPRIGHT CHANNEL	2111-08
	PRIMARY AIR INTAKE	2111-09

HearthStone H-II Exploded View

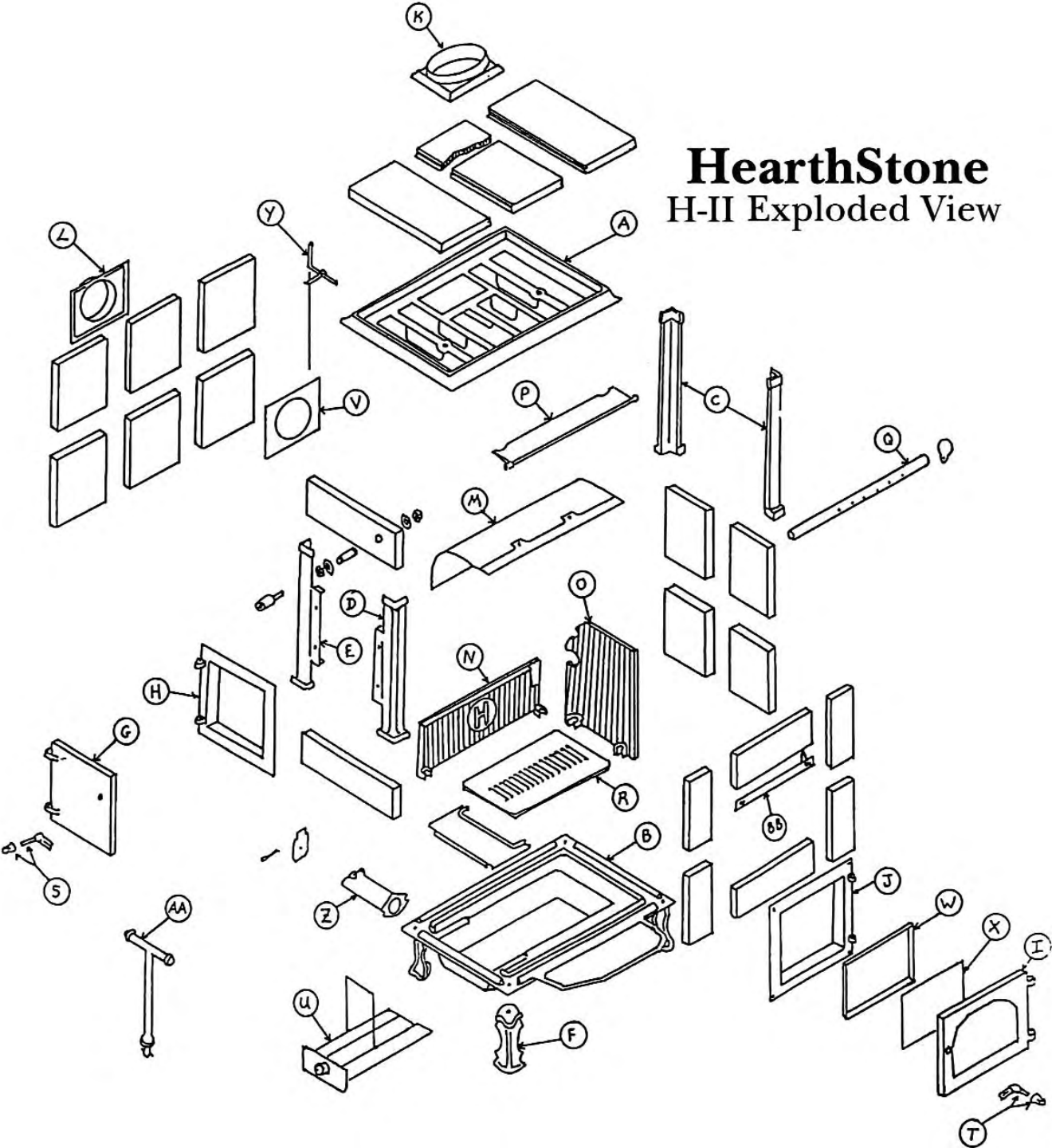

H-II Replacement Parts

REF	DESCRIPTION	ITEM #
A	TOP	2211-02
AA	T-HANDLE	2421-273
B	BOTTOM	2211-03
BB	TOP, FRONT DOOR STEEL	92-58250
BB	BOTTOM, FRONT DOOR STEEL	5000-036
C	RIGHT SIDE LEG	2211-10
D	LEFT FRONT SIDE LEG	2211-24
E	LEFT REAR SIDE LEG	2211-11
F	FOOT	2510-303
G	SIDE DOOR (WITH FRAME)	92-58276
H	S.D. FRAME (WITH SIDE DOOR)	92-58276
I	FRONT DOOR (WITH FRAME)	92-58270
J	F.D. FRAME (WITH FRONT DOOR)	92-58270
K	TOP FLUE COLLAR: OVAL	2211-14
L	REAR FLUE COLLAR	2211-12
L	REVERSIBLE FLUE PLATE	2421-250
L	REVERSIBLE FLUE COLLAR	2010-900
M	BAFFLE	92-58243
	N/A FOR CATALYTIC MODELS	
N	BACK PLATE	92-58240
O	SIDE PLATE	92-58241
P	DAMPER	92-58230
Q	SECONDARY AIR PIPE	92-58245
R	WOOD GRATE	2211-28
S	SIDE DOOR LATCH	92-58220
T	FRONT DOOR LATCH	92-85220
U	ASH DRAWER RETRO-FIT KIT	92-57256
U	ASH DRAWER LATCH	92-58222
	OLD STYLE DOOR & CAMLOCK N/A	
V	INNER REAR FLUE PLATE	2211-13
W	WINDOW FRAME	2211-25
X	GLASS: 10-3/8" X 7-3/8"	92-58205
Y	MANUAL PRIMARY AIR CONTROL	94-58400
	OLD BI-METALLIC COIL N/A	
Z	PRIMARY AIR INTAKE	2211-01
	MISCELLANEOUS PARTS:	
	DAMPER BUSHING ASSEM	90-58000
	REAR HEAT SHIELD	92-57205
	COMBUSTOR: 6" DIA X 2" W	3010-160
	GASKET KIT: DOORS & GLASS	92-58201