

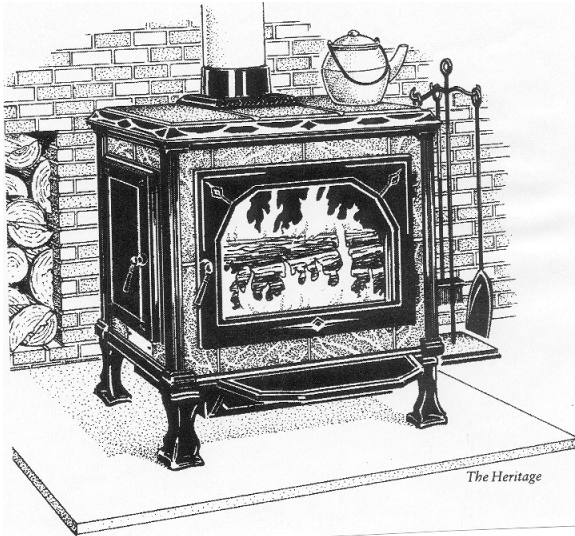

# Heritage (8020) Non-Catalytic Wood Stove



## OWNER'S MANUAL INSTALLATION AND OPERATING INSTRUCTIONS

**PLEASE READ THIS ENTIRE OWNER'S MANUAL BEFORE YOU INSTALL AND USE YOUR NEW Heritage WOOD STOVE. To reduce the risk of fire, follow the installation instructions. Failure to follow these instructions may result in property damage, bodily injury, or even death.**

**SAVE THESE INSTRUCTIONS FOR FUTURE REFERENCE!**

**CONTACT LOCAL AUTHORITIES HAVING JURISDICTION (BUILDING DEPARTMENT or FIRE OFFICIALS) ABOUT PERMITS REQUIRED, RESTRICTIONS AND INSTALLATION INSPECTION IN YOUR AREA.**



Heritage Model# 8020  
Manual # 6400-40420  
Revised May 01, 2001

# TABLE OF CONTENTS

<b>INTRODUCING YOUR HERITAGE WOOD STOVE .....</b>	<b>2</b>
CODES.....	3
SAFETY INFORMATION.....	3
Periodic Checklist.....	4
Emergency Procedures.....	4
SPECIFICATIONS.....	5
<b>SETTING UP YOUR HERITAGE WOOD STOVE .....</b>	<b>6</b>
UNPACKING .....	6
INSTALLING YOUR STOVE.....	6
HEARTH REQUIREMENTS AND FLOOR PROTECTION .....	6
OUTSIDE AIR SUPPLY .....	7
Clearances To Combustibles.....	7
Clearances to Protected Surfaces.....	8
Venting Components and Configuration .....	9
Components of a Venting System.....	9
Installing a Venting System.....	9
CONNECTING YOUR WOOD STOVE .....	10
Connecting to a Prefabricated Metal Chimney.....	10
Connection To A Masonry Chimney.....	11
INSTALLING IN A MOBILE HOME.....	13
<b>OPERATING YOUR HERITAGE WOOD STOVE .....</b>	<b>14</b>
CONTROLS AND FEATURES.....	14
CHOOSING FIREWOOD.....	14
BUILDING A FIRE.....	15
BREAKING IN YOUR WOOD STOVE.....	15
Building A Break In Fire .....	15
Normal Operation .....	16
Building A Fire For Everyday Use.....	16
Burn Rate .....	16
Over-Fire Caution.....	17
Removal And Disposal Of Ashes .....	17
MAINTENANCE.....	17
Monitoring Stove Temperatures .....	17
Creosote Formation And Need For Removal .....	18
Gaskets.....	18
Glass.....	18
Stone .....	19
Cast Iron.....	19
TROUBLESHOOTING.....	19
TROUBLESHOOTING GUIDE.....	21
REPLACEMENT PARTS & OPTIONAL ACCESSORIES.....	22
SAFETY LABEL.....	23

# Introducing Your Heritage Wood Stove

Congratulations! You have just invested in a most unique wood burning stove – the Heritage Wood Burning Stove from HearthStone Quality Home Heating Products Inc®. The Heritage Model –8020 is a clean burning EPA certified, non-catalytic wood burning stove. At 2.03 cubic feet capacity and 2.3 grams per hour particulate you can be proud to join the HearthStone family with our *Premier* Cast Iron Wood Burning Stove. The generous depth allows for loading of wood through the front and the side doors allow for wood up to 20 inches long!

Your purchase insures years of clean, comfortable heat with minimal maintenance. You will receive the benefits of the most advanced technology in wood burning without the cost and maintenance requirements of a catalytic stove. The Heritage blends modern technology with the unique beauty and heating qualities of soapstone, long known for its even heat production and long heat-retaining ability. We trust that you will appreciate the quality of our handcrafted product.

Please read this manual in its entirety. Its purpose is to familiarize you with your stove's safe installation, proper break-in, operation and maintenance. It contains information that will be useful to you now, and in years to come, so keep it handy and refer to it as needed.

Use these instructions as well as national, state, and local building codes to install your stove. Be sure to maintain the designated stovepipe and stove clearances to walls, ceilings, hearth, and other combustible surfaces. This will help reduce the risk of fire. Failure to follow these instructions can result in property damage, bodily injury, and even death.

Locate your stove in a safe, convenient, open area; away from traffic flow, doors, and hallways; and near a chimney and chimney connector. Review the proper clearance measurements from combustible surfaces. You can safely reduce required clearances in most cases with a special connector pipe and special wall coverings as specified by this manual, the NFPA 211 codes, and your local authorities having jurisdiction.

Keep furniture, drapes, curtains, wood, paper, and other combustibles far away from the stove. Never install the stove in a location where gasoline, kerosene, charcoal lighter fluid or other flammable liquids are used or stored.

Locate the stove centrally in your living area to allow the heat to travel naturally to distant rooms. We recommend that you do not locate your stove in an uninsulated basement. The amount of radiant energy required to heat concrete basement walls is so great that most of the usable heat is absorbed by them and lost.

## **SAFETY NOTICE:**

**A HOUSE FIRE MAY RESULT IF THIS STOVE IS NOT INSTALLED PROPERLY. FOR YOUR SAFETY, CAREFULLY FOLLOW THE INSTALLATION DIRECTIONS. CONTACT LOCAL BUILDING OR FIRE OFFICIALS ABOUT RESTRICTIONS AND INSTALLATION INSPECTION IN YOUR AREA.**

The performance of your stove depends on many variables. Since all installations are unique, the general information and operating procedures presented here can only serve as useful guidelines rather than hard and fast rules. Should you have any questions, do not hesitate to contact your dealer for additional information.

Validate your warranty - return your warranty registration card to HearthStone within 30 days of purchase. Once your warranty has been validated by returning your warranty card, contact your dealer for any necessary warranty service.

This stove is manufactured and warranted by:

**HearthStone Quality Home Heating Products Inc®**  
317 Stafford Ave.  
Morrisville, VT. 05661

## CODES

When you install your Heritage wood stove, it is imperative that you adhere to all local codes, which can be obtained from either of the following two National sources:

American National Standards Institute, Inc. (ANSI)  
1430 Broadway  
New York, NY 10018

National Fire Protection Association, Inc. (NFPA)  
Battery March Park  
Quincy, MA 02269

If you are installing your Heritage in a mobile home, follow the guidelines described in the Manufactured Home Construction and Safety Standard, Title 24 CFR, Part 3280 (United States).

## SAFETY INFORMATION

**Read and understand this Owner's Manual thoroughly before installing and using this stove.**

### Make sure to install your stove:

- According to the manufacturer's recommendations.
- In accordance with all applicable codes.
- With the proper sized chimney.

### When using your stove:

- Warn children and others unfamiliar with woodstoves of the danger of touching hot, radiating surfaces of your stove. For your additional safety, obtain hearth and stove guards through your local dealer.
- Follow recommended break-in procedure as outlined in this manual.
- Burn natural wood only. Higher efficiencies and lower emissions result when burning air-dried, seasoned wood, as compared to green or freshly cut wood.
- Use caution when loading firewood into a hot stove.
- Keep the side and front doors closed at all times except when loading wood.

- Keep the ash pan tray fully inserted and the ash door closed tightly.
- Inspect the stovepipe, chimney connector and chimney, as recommended.
- Be sure the removable ash lip is in place while using the stove. If the ash lip is not installed properly, the hearth may exceed safe temperatures.

### Follow these safety precautions:

- Never** modify this stove in any way, especially the primary air control system.
- Never** burn kiln dried wood, painted or treated wood, solvents, trash, plywood, colored or glossy paper, artificial logs, cardboard, coal, garbage or driftwood. *Especially, do not burn coal in this stove.*
- Never** use gasoline type fuel, kerosene, charcoal lighter fluid, or other liquid fuels or solid fire starters to start or invigorate the fire. These fuels can possibly generate carbon monoxide, which can sap the supply of oxygen. Keep all such materials away from the stove.
- Never** use the stove if the ash pan door is open, damaged, not in place, or not sealing.
- Never** use a wood grate or other device to elevate the fire.
- Do Not** allow logs to rest against or otherwise come in contact with the glass when the door is closed.
- Do Not** slam the door or use the door to force wood in to the stove.
- Never** over-fire your stove. (See page 17)
- Never** put articles of clothing or candles on a hot stove.
- Do Not** connect the stove to a flue that is serving another appliance.

### Other safety guidelines

- ❑ Keep all combustible items such as furniture, drapes, clothing, and other items, at least 36" (0.92 m) from the stove (See page 7)
- ❑ Install a smoke detector, preferably in an area away from your wood stove.
- ❑ Keep a fire extinguisher handy. We recommend the type rated "A B C."
- ❑ Dispose of ashes properly. (See page 17)
- ❑ Keep children and pets away from the stove; they could be burned by touching a hot stove.
- ❑ Clean your chimney system as needed. (See page 17)

### PERIODIC CHECKLIST

Perform each of these tasks at the specified intervals.

#### At the End of Every Week:

- Empty ashes from the firebox and ash pan, sooner if the firebox or the ash pan begins to fill up.

#### At the Beginning of Every Other Month:

- A visual inspection of the chimney connector and chimney for creosote is recommended depending upon your use of the stove. (Please see page 17- Creosote Formation and Need For Removal)
- Check door seals using the "dollar bill test." - When the fire is out and the stove is cool, shut the door on a dollar bill. If the bill pulls out without any resistance, then your stove's door isn't sealed properly. To tighten the seal, change the door gasket. (Refer to page 17 – Gaskets)

#### At the End of Every Season:

- Dismantle the chimney connector and clean it thoroughly. Replace any pieces that show signs of rust or deterioration.
- Inspect and, if necessary, clean your chimney.

- Thoroughly clean out the inside of the stove.
- Inspect all door gasket material and replace if worn, frayed, cracked or extremely hard.

### EMERGENCY PROCEDURES

If you have a stovepipe or chimney fire, follow these instructions:

1. If the fire is too threatening, leave the area and call the fire department immediately! If not, perform the next three steps.
2. Close the primary air control.
3. Close the stovepipe damper (if present).
4. Keep the stove front, side and ash doors closed!

### WARNING

DO NOT ATTEMPT TO PUT OUT A STOVEPIPE OR CHIMNEY FIRE BY THROWING WATER ONTO THE STOVE, STOVEPIPE, OR CHIMNEY. THE EXTREMELY HIGH TEMPERATURE ASSOCIATED WITH SUCH FIRES CAN CAUSE INSTANTANEOUS STEAM AND SERIOUS BODILY HARM.

Once the chimney fire has expired, leave the primary air control closed and let the fire in the stove die out completely. The stove should not be fired again until the stove, stovepipe, and chimney are all thoroughly inspected for any sign of damage. You must correct any damage before using your stove again.

## SPECIFICATIONS

<b>Maximum Heat Output.</b>	55,000 BTUs per hour of cordwood (based on independent laboratory test results).	<b>Front Door Size</b>	18" wide x 12" high (46 x 31 cm)
<b>Size Of Heated Area.</b>	1,500 to 2,000 square feet.	<b>Side Door Size</b>	9" wide x 10 x 9-5/8" high (25 x 24 cm)
<b>Firebox Capacity.</b>	2.03 cubic feet (.057 cubic meters) or 44 pounds of wood (The amount and weight of wood contained per cubic foot of firebox volume can vary from 15 to 36 lbs. per cubic foot depending on type of wood, moisture content, packing density and other factors. As a constant for comparison and test purposes, we are assuming 20 lbs. of seasoned hardwood per cubic foot of firebox volume).	<b>Stovepipe Size</b>	6" (152 mm) diameter
<b>Maximum Log Length.</b>	20" (51cm) - front and Side doors	<b>Metal Chimney</b>	6" (152 mm) inside diameter
<b>Height</b>	31" (79 cm)	<b>Masonry Chimney</b>	6" (15.2cm) inside diameter (round flue) 8" x 8" (20 x 20cm) (square flue)
<b>Width</b>	27" (69 cm)	<b>Flue Exit</b>	Top exit only
<b>Depth</b>	24" (61 cm)	<b>Actual Weight</b>	475 (216 kg) pounds
		<b>Crate Dimensions</b>	H-38" (97cm) w-32" (81 cm) L-32" (81 cm)
		<b>Optional Equipment</b>	Rear Heat Shield Outside Air Kit Blower
		<b>Soapstone Finish<sup>1</sup></b>	Polished Gray Soapstone
		<b>Castings Finish</b>	Painted Matte; and Porcelain Enamel (green, brown, Almond, Navy and Black)

---

<sup>1</sup> Polished gray soapstone is a natural product and will vary from stone to stone. Various amounts of gray, charcoal, blue and green will be evident according to the natural composition of the stone.

# Setting Up Your Heritage Wood Stove

## UNPACKING

HearthStone Stoves packages your Heritage stove with the greatest care, so that it ships safely. Under certain circumstances, however, damage can occur during transit and handling. When you receive your stove, unpack it carefully, inspecting your stove and all parts for damage. Also, make sure that all parts are included in the box. If any parts are damaged or missing, please contact your dealer immediately.

## INSTALLING YOUR STOVE

First, you must decide where your stove will reside. After choosing an appropriate spot, inspect this location to make sure that the stove will have enough clearance to combustible materials that would surround the stove. These combustibles can include walls, floor, ceiling, fireplace, and chimney. You must carefully consider the clearances to all of these combustibles before actually connecting your stove. When considering these clearances, also decide the kind of floor the stove will rest on. Depending on your floor, you can install your stove as it is, or use a floor protector.

Please use this section to plan how to locate your stove in your particular location. Consider both the clearances of the stovepipe and the stove itself to the surrounding combustibles.

The soapstone walls of the Heritage soapstone stove produce and even, radiant heat. Locate the stove centrally in your living area to allow the heat to travel naturally to distant rooms. It is not recommended that you locate your stove in an uninsulated basement. The amount of radiant energy required to heat concrete basement walls is so great that most of the usable heat is absorbed by them and lost.

Read this chapter to obtain a sound understanding of how to properly install your stove.

If you use a close clearance connector pipe, it must be tested to UL standards and listed. Check the listing of your pipe for actual clearances. The diagrams in this manual represent typical installations, but are specific to the Simpson Dura-Vent DVL brand. Clearances cannot be reduced without the use of close clearance connector pipe and/or by protecting the surfaces per NFPA 211 standards.

## Clearances To NFPA 211 Protected Surfaces

You can reduce the clearances to combustible surfaces by using any National Fire Protection Agency (NFPA) approved wall protection system. Please refer to NFPA 211 for specifications and complete details. You can obtain this information directly from NFPA.

National Fire Protection Agency  
Batterymarch Park  
Quincy, MA 02269  
1-800-344-3555  
1-617-770-3000

## HEARTH REQUIREMENTS AND FLOOR PROTECTION

Combustible flooring must be protected with a covering of noncombustible material (slate, marble tiles, other noncombustible material can be used for this purpose). The floor protection must extend beyond the body of the stove at the minimum as follows:

- LEFT SIDE 16" (40.64 cm)\*
- RIGHT SIDE 8" (20.32 cm)
- REAR 2" (5.08 cm)\*\*
- FRONT 16" (40.64 cm)\*

\* Installations in Canada require 18" (45.72 cm) of floor protection on the left side and front.

\*\* Rear clearance required only if stovepipe runs horizontally back from the top of the stove.

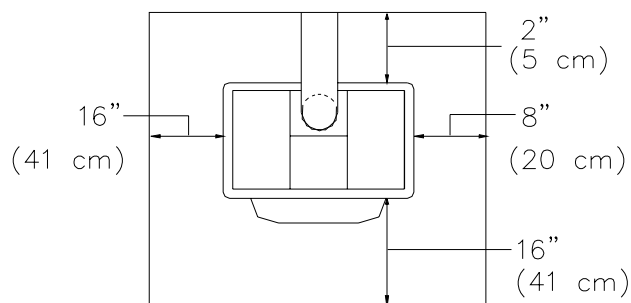

## OUTSIDE AIR SUPPLY

An outside air source may be connected directly to this stove using an optional outside air kit. The advantage of providing outside air directly to the stove is that the air used by the stove for combustion is taken from outside of the residence rather than from within the room where the stove is located. With outside air supplied directly to the stove, drafts within the room and air infiltration within the building are reduced. Use of the outside air kit may also improve stove performance in a particularly airtight house.

The outside air kit for this stove allows for the direct connection of the stove's air intake to a minimum 3" (76 mm) diameter duct (supplied by others) which leads to the outside of the house. When considering placement of the duct from the outside of the house to the hearth, keep in mind the need to avoid structural members of the house. The outside air kit will attach to the bottom of the stove. Before installing the kit, determine where the duct for the

outside air will terminate. The duct can terminate from the back center of the ash dump box or the center of the right side of the ash dump box by changing the position of the screw-on plates and the adaptor.

NOTE: If you intend to use the optional blower, you will not be able to use the rear outlet on the outside air box. When using a blower the outside air duct must connect to the right side of the outside air box.

The termination of the duct on the outside wall of the stove should be located in such a manner so as to preclude the possibility of obstruction by snow, leaves or other material and should be screened against animals and insects. The termination should be screened using

$\frac{1}{4}$ " x  $\frac{1}{4}$ " mesh rodent screen and be covered with a rain/wind proof hood (flex pipe, outside termination, mesh, and hood supplied by others. Contact your dealer for availability).

## CLEARANCES TO COMBUSTIBLES

### Using Single Wall Stove Pipe Without Heat Shield

- Residential and Mobile Home installations for USA/Canada – maintain 18" minimum clearance between horizontal chimney connector and ceiling.

#### Parallel Installation:

- A: Back wall to stove: 25" (63.5 cm)
- B: Right sidewall to stove: 16" (40.64 cm)
- C: Left sidewall to stove: 20" (50.8 cm)
- E: Flue collar to back wall: 27" (68.58 cm)

#### Corner Installation:

- D: Wall to stove corner: 18" (45.7 cm)

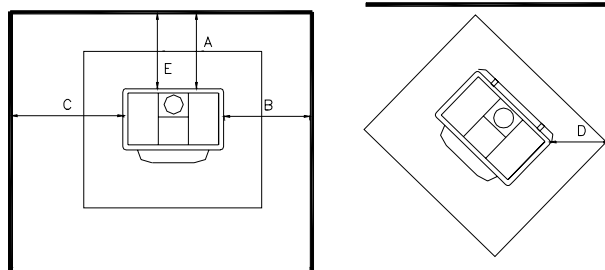

### Using Single Wall or Close Clearance Stove Pipe With Rear Heat Shield

- Residential and Mobile Home Installations for USA/Canada

#### Parallel Installation:

- A: Back wall to stove: 10" (25.40 cm)
- B: Right sidewall to stove: 16" (40.64 cm)
- C: Left sidewall to stove: 20" (50.8 cm)

#### Corner Installation:

- D: Wall to stove corner: 12" (30.48 cm)

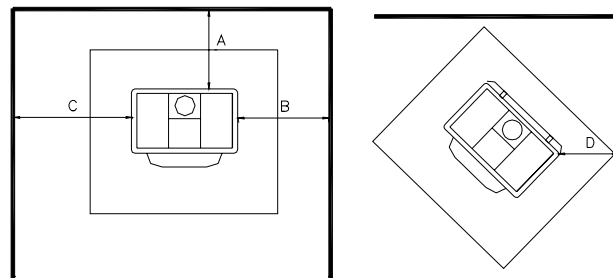



## Using Single Wall or Close Clearance Stove Pipe With Rear Heat Shield AND NFPA 211

### PROTECTED SURFACE

- Residential and Mobile Home Installations for USA/Canada

#### Parallel Installation:

- A: Back wall to stove: 4" (10.1 cm)
- B: Right sidewall to stove: 6" (25.8 cm)
- C: Left sidewall to stove: 6" (25.8 cm)

#### Corner Installation:

- D: Wall to stove corner: 5" (12.70 cm)

**Note:** The stove must be bolted to the floor when installing it into a mobile home.

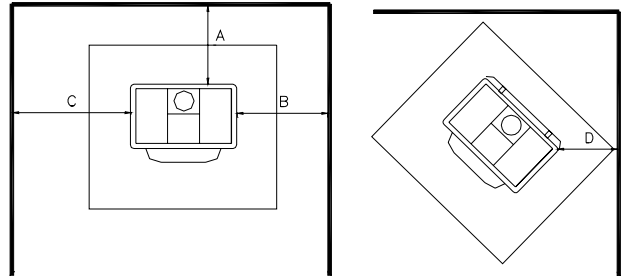

### Alcove With Rear Heat Shield NFPA 211 Wall Protection

#### Parallel Installation:

- A: Back wall to stove: 6" (15.24 cm)
- B: Right sidewall to stove: 4" (10.16 cm)
- C: Ceiling to top of stove: 41" (104.14 cm)
- D: Maximum alcove depth: 48" (121.92 cm)
- E: Flue collar to back wall: 6" (15.24 cm)

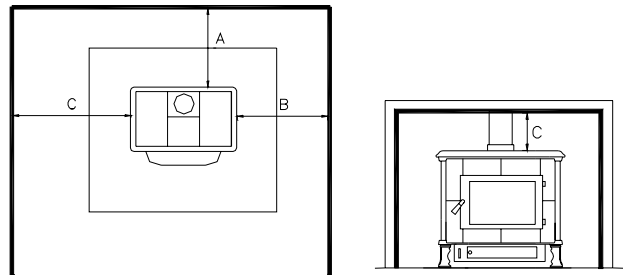

### CLEARANCES TO PROTECTED SURFACES

Clearances to combustible surfaces can be reduced by using any NFPA approved wall protection system.

REFER TO NFPA 211 FOR SPECIFIC AND COMPLETE DETAILS:

National Fire Protection Agency  
Battery March Park  
Quincy, MA 02269  
1-800-344-3555  
1-617-770-3000

It is very important to follow minimum clearances for chimney connectors to combustibles such as walls and ceilings when installing the stove near non-combustible surfaces.

## VENTING COMPONENTS AND CONFIGURATION

### DO NOT CONNECT THIS UNIT TO A CHIMNEY FLUE SERVING ANOTHER APPLIANCE

- Single wall connector is 24 MSG or 25 MSG blued steel stovepipe.
- Double wall connector (close clearance pipe) which must be used with a listed factory-built "Type HT" chimney also may be used with a masonry chimney to reduce clearances, is available from several manufacturers, your dealer can help you choose. Some air insulated connector pipe models available are Simpson Dura Vent DVL and Metalbestos DS. Security, GSW and Ameritec also have acceptable close clearance connector pipe.
- When used in a mobile home, a spark arrester is required. (See page 13)
- Chimney connector shall not pass through floor or ceiling, nor any attic or roof space, closet or similar concealed space. Where passage through a wall or partition of combustible construction is desired, the installation shall conform to NFPA 211 or CAN/CSA - B365.
- It is very important to follow minimum clearances for chimney connectors to combustibles such as walls and ceilings when installing the stove near non-combustible surfaces. Typical chimney connector clearances are outlined below. The single wall clearances are generic; the Double wall clearances are for Simpson Dura Vent DVL, **CHECK THE SPECIFICATIONS FROM THE MANUFACTURER OF YOUR CONNECTOR.**

### COMPONENTS OF A VENTING SYSTEM

The complete venting system consists of several components: chimney connector, wall thimble, wall pass-through, chimney, and liner. It is *absolutely necessary* that you install all of these components within the clearances to combustibles discussed earlier to install your stove safely.

To protect against the possibility of a house fire, you *must properly install and constantly maintain the venting system*. Upon inspection, immediately replace rusted, cracked, or broken components.

- The *chimney connector* is the stovepipe from the woodstove to the chimney. The chimney connector stovepipe must be 6" (152 mm) diameter, 24 MSG or

25 MSG blued steel connector pipe. *Do not use aluminum or galvanized steel pipe* - they cannot withstand the extreme temperatures of a wood fire.

- A *thimble* is a manufactured (or site-constructed) device installed in combustible walls through which the chimney connector passes to the chimney. It keeps the walls from igniting. You must use a wall thimble when installing a chimney connector through a combustible wall to the chimney.
  - A *wall pass-through* (or chimney support package) also keeps the walls from igniting. You must use one when connecting through a wall or ceiling to a prefabricated chimney.
  - Only install this stove to a *lined masonry chimney* or an approved high temperature *prefabricated residential* type building heating appliance chimney. *Do not* connect this stove to a chimney serving another appliance; you will compromise the safe operation of both the wood stove and the connected appliance.
- WARNING:**  
DO NOT CONNECT THIS APPLIANCE TO ANY AIR DISTRIBUTION DUCT OR SYSTEM.
- A *liner* is the UL 1777 or ULC S635 (for factory built fireplace or masonry) chimney.

You must connect your stove to a chimney comparable to those recommended in this manual. *Do not use stovepipe as a chimney*. Use stovepipe for freestanding installations only to connect the stove to a proper chimney.

### INSTALLING A VENTING SYSTEM

Stovepipe sections must be attached to the stove and to each other with the crimped end toward the stove. If creosote builds up, this allows the creosote to run into the stove and not the outside of the stovepipe and onto the stove.

Secure all joints, including attaching the stovepipe to the stove's flue collar, with three sheet metal screws. Install #10 x 1/2" (3 mm x 13 mm) sheet metal screws into the holes pre-drilled in the flue collar. Leaving off the screws can cause joints to separate from the vibration that results from a creosote chimney fire.

You can simplify connecting stovepipe by using additional accessories such as telescoping pipes, slip-connectors or clean-out tees. These accessories ease the inspection of your chimney, as well as allow you to easily

dismantle the stovepipe (without moving the stove) when you periodically inspect the stovepipe connection and chimney.

Install the stove as close as practical to the chimney, while maintaining all proper clearances. Install stovepipe that is as short and as straight as possible. Horizontal runs of stovepipe should always rise away from the stove a minimum of 1/4" per foot (21mm/m).

*Long runs of stovepipe to increase heat dispersal are not recommended.* Using longer lengths of stovepipe or more connecting elbows than necessary increase the chances of draft resistance and the accumulation of creosote buildup.

In general, you do not need to install a stovepipe damper with the Heritage. Some installations, however, could benefit from a stovepipe damper, such as a tall chimney which can create a higher than normal draft. In such cases, a damper can help regulate the draft. The Heritage requires a draft between 0.06" wc and 0.1" wc. For drafts above 0.1" wc, install a stovepipe damper.

Remember, the NFPA has recommended, minimum clearances for chimney connectors to combustibles such as walls and ceilings. Once the stove is installed at safe distances from these combustible surfaces, it is important to maintain these connector clearances for the remainder of the installation.

## CONNECTING YOUR WOOD STOVE

You can install your Heritage to a prefabricated metal chimney or a masonry chimney.

### CONNECTING TO A PREFABRICATED METAL

- An *exterior* installation where the chimney passes through the wall behind the stove then up the outside of the residence.

Whenever possible, choose an interior chimney. An interior chimney heats up more quickly and retains its heat; thus promotes a better draft and discourages the

## CHIMNEY

When connecting the Heritage to a prefabricated metal chimney, you must follow, precisely, the manufacturer's installation instructions. Use only Type HT (2100 deg. F), prefabricated metal chimneys listed per UL 103 or ULC S629 standards.

### WARNING:

**DO NOT CONNECT THE STOVE TO A CHIMNEY FLUE SERVING ANOTHER APPLIANCE.**

Make sure the size of the chimney's flue is appropriate for the Heritage. The Heritage requires a 6" (152 mm) inside diameter flue for new installations. A 6" diameter flue provides adequate draft and performance. You can use an 8" (203 mm) diameter existing flue with a reducer. An oversized flue contributes to creosote accumulation. (In this case, bigger is NOT better.)

When purchasing a prefabricated chimney to install with your stove, be sure to also purchase from the same manufacturer the wall pass-through (or ceiling support package), "T" section package, fire-stops (when needed), insulation shield, roof flashing, chimney cap, and any other needed accessories. Follow the manufacturer's instructions when installing the chimney and accessories. In addition, be sure to maintain all manufacturers' recommendations for the proper clearances to the chimney.

There are two ways to install a prefabricated metal chimney:

- An *interior* installation where the chimney passes inside the residence through the ceiling and roof.

formation of creosote. An exterior chimney does not benefit from the warmth of being surrounded by the building, so it typically operates at lower flue temperatures than an interior chimney. An exterior chimney's draft is not as strong and may experience increased creosote accumulation.

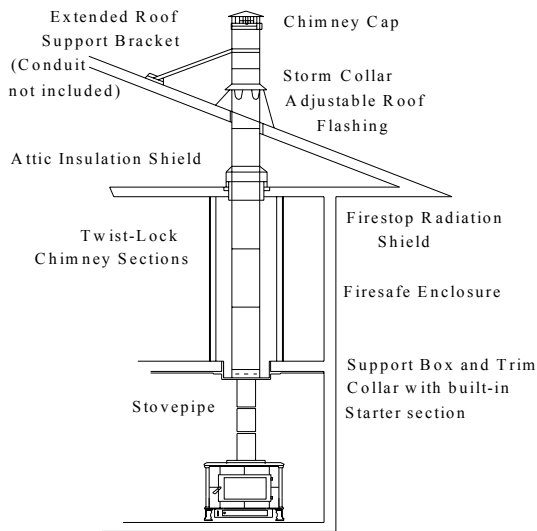

Two story house installation with attic.

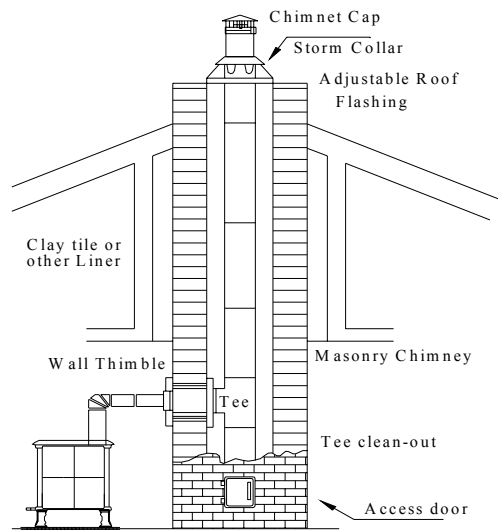

Chimney pipe through Clay tile or other Lined Masonry Chimney

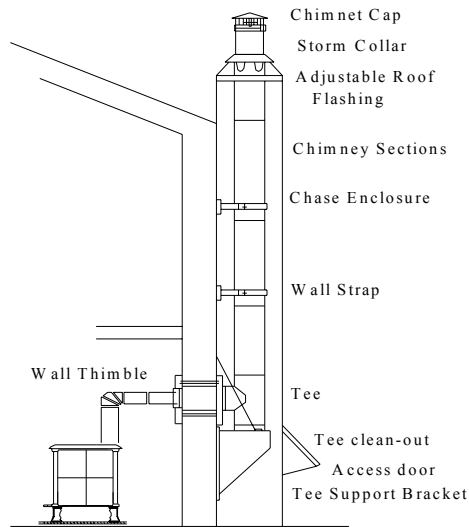

Chimney through outer wall with enclosed chase. Chimney is supported by Tee Support Bracket.

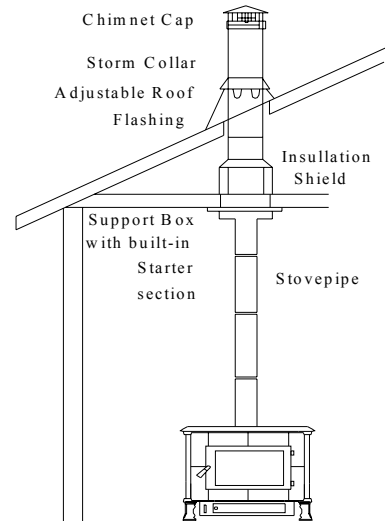

One story house installation with attic. Chimney is supported by Ceiling.

## CONNECTION TO A MASONRY CHIMNEY

Consider two primary elements when connecting your stove to a masonry chimney: the chimney itself and the thimble where the stovepipe connects to the chimney. Use only Code approved masonry chimneys with a flue liner.

Before connecting to a masonry chimney, hire a professional to examine the chimney for cracks, loose mortar, and other signs of deterioration and blockage. If the chimney needs repair, complete them before installing and using your stove. Do not install your stove until the chimney is safe for use.

Make sure the chimney's cleanout is complete and working properly. To avoid a loss of draft, the cleanout must close off completely. If allowed to cool, your stove will perform poorly and creosote will build up in the chimney.

Make sure the size of the chimney's flue is appropriate for this stove and that it is not too large. Use a masonry chimney with an 8" x 8" (203 mm x 203 mm) tile size for best results. An oversized flue will contribute to the accumulation of creosote.

Use the following checklist to ensure that your masonry chimney meets these minimum requirements:

Chimney wall construction:

- ❑ Brick or modular block at least 4" (102 mm) thick.
- ❑ A rubble or stone wall.

Flue liner:

- ❑ Minimum thickness of 5/8" (16 mm).
  - ❑ Installed with refractory mortar.
  - ❑ At least 1" (25 mm) air space.
  - ❑ An equivalent flue liner must be a listed chimney liner system meeting type HT requirements or other approved material.
- Interior chimney requirements:
- ❑ At least 2" (51 mm) clearance to combustible structure

- ❑ Fire stops must be installed at the spaces where the chimney passes through floors and/or ceiling.
- ❑ Insulation must be 2" (51 mm) from the chimney.

Exterior chimney requirements:

- ❑ At least 1" (25 mm) clearance to combustible structure.

Chimney height requirements: (See Illustration)

- ❑ At least 3 feet (0.9 m) higher than the highest part of the roof opening through which it passes.
- ❑ At least 2 feet (0.6 m) higher than any part of the roof within 10 feet (3 m) measured horizontally from the top of the chimney.

This stove requires a minimum chimney height of 13 feet (4 m). The maximum allowable chimney height is 30 feet (9m).

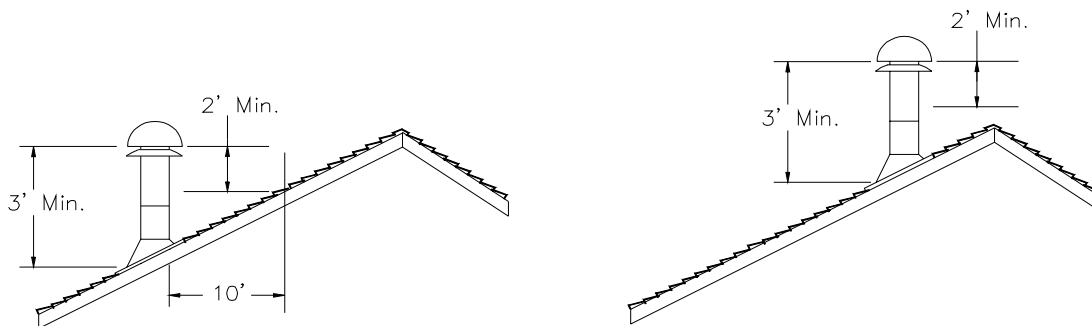

## INSTALLING IN A MOBILE HOME

Follow these special requirements for installing your stove in a mobile home.

- Install the stove in accordance with 24 CFR, Part 3280 (HUD)
- Permanently attach the stove to your mobile home's floor. Use 1/4" holes in each leg base to bolt down the stove.
- Install one of the following Dura-Vent Mobile Home Chimney & Connector Kits:
  - 6DP-MH 6" Diameter S/N 9096N
  - 7DP-MH 7" Diameter S/N 9196N
  - 8DP-MH 8" Diameter S/N 9296NEach kit includes:
  - Stainless spark arrester cap, storm collar, Adjustable vented flashing – 0/12 – 6/12, Two 24" Dura/Plus\* chimney pipes, 24" support box with built-in starter section and trim.

\* (UL or ULC approved equipment is acceptable)
- Chimney must be removed when transporting Mobile Home.

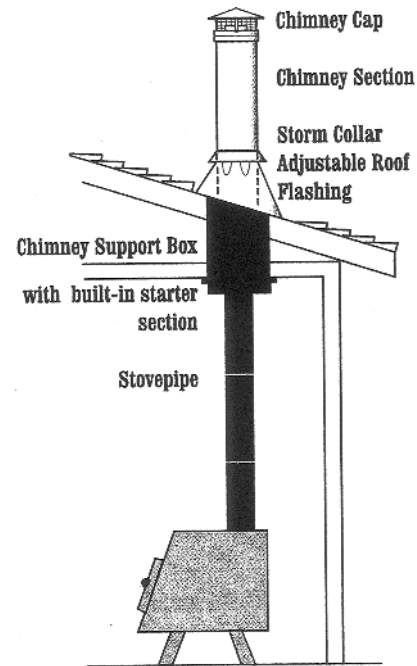

Typical Mobile Home installation. Chimney supported by ceiling.

### WARNING:

DO NOT INSTALL IN A SLEEPING ROOM

### CAUTION:

MAINTAIN THE STRUCTURAL INTEGRITY OF THE MOBILE HOME WALLS, FLOOR, CEILING, AND ROOF WHILE YOUR STOVE IS INSTALLED AND IN USE.

# Operating Your Heritage Wood Stove

Once your Heritage has been set in place, connected, and assembled, you are ready to light a fire. HearthStone Stoves tests each wood stove before we ship, so you should be able to easily light your first fire.

**WARNING:**  
**HOT WHILE IN OPERATION. KEEP CHILDREN, CLOTHING AND FURNITURE AWAY. CONTACT MAY CAUSE SKIN BURNS.**

Please read this entire chapter before lighting your first fire. It explains the controls and features of your wood stove, how to choose firewood, and how to break-in your stove and use it on a daily basis.

## CONTROLS AND FEATURES

Before lighting any fires, become familiar with the location and operation of your stove's controls and features and learn how to use them. For your own safety, do not modify these features in any way.

**FRONT DOOR HANDLE:** The front door allows you to load wood into your stove; a fixed handle allows you to operate the front door and allows you to latch the front door closed. To open the doors, lift the handle to the 10 o'clock position and pull the door. To latch the doors, push the door closed tightly then lower the handle to the 7 o'clock position. Pull on the door handle to make sure it is properly latched.

**SIDE DOOR HANDLE:** The side door allows you to load wood into your stove; a fixed handle allows you to operate the side door and allows you to latch the door closed. To open the door, lift the handle to the 11 o'clock position and pull the door. To latch the door, push the door closed tightly then lower the handle to the 7 o'clock position. Pull on the door to make sure it is properly latched.

**PRIMARY AIR CONTROL:** The handle is located on the front bottom left of the stove, beside the ash door latch. The primary air control allows you to regulate the amount of air entering the firebox. Generally, the more air allowed into the firebox, the faster and hotter the rate of burn; conversely, less air creates a slower burn. To fully open the primary air intake, push the handle as far as it will go to the left away from the firebox; push the handle

as far as it will go to the right, towards the firebox to close the primary air control.

**ASH PAN:** The ash pan and ash pan access door is located under the ash lip. The ash pan collects burned ash from a fire and allows you to conveniently remove the ash from your wood stove. The firebox should be cleared of ashes daily by sliding the ash grate sideways, sifting the ashes across the grate into the ash pan, then returning the grate to its closed position. To access the ash pan, turn the ash door handle counter-clockwise, and pull the door open. The ash pan is easy to remove and has a handle for convenient disposal of ashes. Before removing the ash pan, push it (hard!) into the stove to force the pan up the slope, which kicks the ashes further into the pan. To close the ash door, push the door closed and turn the handle clockwise.

**Do not operate the stove unless the ASH PAN is inserted into the stove and the ash door is closed. This could overheat and damage the stove.**

## CHOOSING FIREWOOD

Your Heritage Wood Heater is designed to only burn firewood-also known as cordwood.

**CAUTION:**  
**DO NOT USE CHEMICALS OR FLAMMABLE FLUIDS SUCH AS GASOLINE, NAPHTHA, KEROSENE, CHARCOAL LIGHTER FLUID OR ENGINE OIL TO START A FIRE. DO NOT USE CHARCOAL, PELLETS, COAL, ARTIFICIAL LOGS OR ANY OTHER MATERIALS AS FUEL; THEY ARE NOT SAFE. DO NOT BURN GARBAGE.**

The quality of your firewood affects heat output, duration of burn and performance of your stove. Softwoods generally burn hotter and faster, while hardwoods burn longer and produce more coals. Density and moisture content are two critical factors to consider when purchasing wood for your stove.

The following is a list of wood species and their relative BTU (British Thermal Unit) content. The higher the BTU the longer the burn. Firewood with higher BTUs is generally considered ideal for a wood stove.

*HIGH:* Apple, Black Birch, Hickory, Locust, White Oak, Black Beech, Mesquite

*MEDIUM HIGH:* White Ash, Beech, Yellow Birch, Sugar Maple, Red Oak

*MEDIUM LOW:* Black Ash, White Birch, Grey Birch, Elm, Norway Pine, Pitch Pine, Black Cherry, Soft Maple, Tamarack

*LOW:* White Pine, White Cedar, Balsam Fir, Spruce, Aspen, Basswood, Butternut, Hemlock

Moisture content also plays a key role in the performance of your stove. Wood freshly cut from a living tree (green wood) contains a great deal of moisture. As you might expect, green wood has difficulty burning and should be seasoned before using it in your wood stove. To properly season green wood, it should be split, stacked and allowed to air dry for a period of one year.

Stack the firewood on skids or blocks to keep it off the ground, cover only the top of the stack. Plastic or tarps that cover the sides of the woodpile trap moisture and prevent the wood from drying. As for stacking, an old Vermonter said, "The spaces between the logs should be large enough for a mouse to get through, but not for the cat that's chasing it."

Firewood should not be stored within the stove's specified clearances to combustible materials.

## **BUILDING A FIRE**

Once you understand the controls of your wood stove and have chosen the appropriate firewood, you are ready to start a fire.

## **BREAKING IN YOUR WOOD STOVE**

It is imperative that your stove be "broken in" slowly. Cast iron must be "seasoned"; over-firing a new stove may cause castings to crack or may damage other stove parts. Moisture in the soapstone must be driven out slowly to minimize the "shock" to the stone of its first exposure to high firebox temperatures. In addition, the asbestos-free furnace cement must be cured slowly to insure adequate sealing and bonding.

When you light your first fires, the wood stove will emit some smoke and fumes. This is normal "off-gassing" of the paints and oils used when manufacturing the wood stove. If you find it necessary, open a few windows to vent your room. The smoke and fumes will usually subside after 10 to 20 minutes of operation. The odor and smoke will end once the stove is "cured".

The first fires may produce other odors from impurities that exist in the area immediately surrounding the stove. Some of these impurities can be cleaning solvents, paint solvents, cigarettes, smoke, pet hair, dust, adhesives, a new carpet, and new textiles. These odors will dissipate over time. You can alleviate these odors by opening a few windows or otherwise creating additional ventilation around your stove. If any odor persists, contact your dealer or an authorized service technician.

If you adhere to the following break-in procedure, as well as all other operating procedures in this manual, the cast iron and soapstone components of your stove will give you many years of trouble-free use. With use, the color of the soapstone may change and small fractures may appear on the surface of the stone. These changes will only add character and distinction to your stove.

Avoid the following conditions that can cause the soapstone or cast iron pieces to break:

- Do not throw wood into the stove.
- Do not use the doors as leverage to force wood into the stove.
- Do not load wood that is encrusted with ice into a burning stove as the thermal shock can cause damage.
- Do not use a manufactured grate. Burn the fire directly on the soapstone that lines the bottom of the firebox.

The bottom layer of soapstone in the firebox is intended to prevent thermal stress and should remain in place in the fire box at all times.

## **BUILDING A BREAK IN FIRE**

- 1) Open the front or side door and place five or six double sheets of tightly twisted newspaper in the center of the firebox. Arrange kindling in a crisscross pattern over the newspaper. Kindling should be approximately ten pieces, 1/2" (13 mm) in diameter and 10" to 18" (254 mm to 457 mm) long.
- 2) Fully open the primary air control by pushing the control handle fully to the left, away from the firebox.
- 3) Light the paper under the kindling. Close the side door and leave the front door slightly ajar momentarily until the kindling has started to burn and draft begins to pull.



- 4) Close the door and allow the fire to burn. Keep both the front and side doors closed while the stove is in use. Make sure the grate is in the closed position and the ash drawer is tightly closed.
  - 5) **KEEP A WATCHFUL EYE ON YOUR STOVE** to maintain a steady, low-heat fire. Your first fire should make the stove warm but **not hot to the touch**. At most, a few small chunks of wood should be added to the fire to reach safe break-in temperatures.
  - 6) Once the stove is warm but **not hot to the touch**, close the primary air control by pushing it fully to the right to allow the fire to die out completely.
  - 7) Let the stove return to room temperature.
- 3) Light the paper under the kindling. Leave the front door slightly ajar momentarily until the kindling has started to burn and draft begins to pull.
  - 4) Close the door and allow the fire to burn.
  - 5) Once the kindling is burning, open the front or side door and add logs, small at first, to build the fire up. Make sure to keep the logs away from the glass in front in order for the air-wash system to work properly. Otherwise, keep the doors and ash drawer closed while the stove is in use.
  - 6) Once the fire is burning well, use the primary air control to regulate the desired rate of burn. Pushing the handle to the left opens the **PRIMARY AIR CONTROL** for a high rate of burn or pushing it to the right for a low rate of burn.

Your first fire and first fire each season thereafter should be built and maintained as outlined above. Your patience will be rewarded by a properly seasoned stove.

NOTE: Because of the cool flue gas temperatures present during the break-in procedure, creosote may build up quickly. Your window may get dirty. A good hot fire will clean it. We recommend a visual inspection (and cleaning if necessary) of your stovepipe and chimney once the break-in procedure is completed.

## NORMAL OPERATION

If your stove is not used continuously or has not been used in quite some time, follow the break-in procedure at least once to minimize the stress of a hot fire on a cold stove before proceeding with normal operation. We recommend one break-in fire at the start of each heating season. Prior to loading the stove, make sure the ash grate and the ash pan door are closed. If they are left open, the stove will over-fire and be damaged.

## BUILDING A FIRE FOR EVERYDAY USE

- 1) Open the front or side door and place five or six double sheets of tightly twisted newspaper in the center of the firebox. Arrange kindling in a crisscross pattern over the newspaper. Kindling should be approximately ten pieces, 1/2" (13 mm) in diameter and 10" to 18" (254 to 457 mm) long.
- 2) Fully open the primary air control by pushing it completely to the left, away from the firebox.

Note: When opening the front or side door to reload or re-arrange logs, it is advisable to open the door just a crack, pause for a moment then open the door completely. This procedure will allow the firebox to clear of smoke before the door is opened fully. Also, reloading on a bed of hot, red coals reduces smoking time and will bring fresh fuel up to a high temperature rapidly.

## BURN RATE

**HIGH BURN:** Fully load the firebox with wood on a bed of hot coals or on an actively flaming fire and fully open the primary air control by pushing it fully to the left, away from the firebox. This will fully uncover the primary air shutter. A high burn rate is recommended once or twice a day to fully heat the stovepipe and chimney, which will help minimize creosote accumulation.

**MEDIUM HIGH BURN:** With the primary air control in the closed position, push the control handle to the left  $\frac{3}{8}$ ".

**MEDIUM LOW BURN:** With the primary air control in the closed position, push the handle  $\frac{5}{16}$ " to the left. A medium-low burn rate should be the typical setting and is preferable if the stove is to be left unattended.

**LOW BURN:** Close the primary air control by pulling it fully out until it stops then push it in  $\frac{1}{4}$ " for a low burn rate. A low burn rate over extended periods of time is not advisable as it may promote the accumulation of creosote. The venting system should be inspected frequently if low burn rates are maintained consistently.

NOTE: If equipped with a blower the following blower settings are recommended:

Low and Medium-Low Burn: Set blower on low by turning the control knob clockwise until the blower is running at a low speed.

Medium High and High Burn: Set blower on high by turning the control knob until the blower is running at a high speed. The blower will be at its highest setting when the control knob is turned clockwise to the "ON" position. By continuing to turn the control knob clockwise, the blower speed will be reduced until it reaches its lowest setting. It is recommended that the blower is not turned on for the first 30 minutes of operation.

## OVER-FIRE CAUTION

Over-firing means the stove is operating at temperatures above the recommended temperatures outlined above in the *BURN RATE* section. Over-firing should be carefully avoided since it will cause damage to the stove. Symptoms of over-firing include short burn times, a roaring sound in the stove or stovepipe, and discoloration of the stovepipe.

Over-firing can be caused by excessive draft, inappropriate fuel, and operator error. Correct an over-fire situation as follows:

**EXCESSIVE DRAFT:** Contact your dealer to have a draft reading taken. Any draft in excess of 0.1 w requires a damper in the stovepipe. Some installations may require more than one damper.

**INAPPROPRIATE FUEL:** Do not burn coal, kiln dried lumber, wax logs or anything other than natural cordwood.

**OPERATOR ERROR:** Make sure all the gaskets are in good condition. Replace worn out or compressed gaskets. Do not burn the stove with the front, side, ash door, as well as the ash grate in the open position.

Monitoring the temperature of the surface of the top stones is the best way to determine if the stove is over-firing. If you suspect that your stove is over-firing, contact your dealer immediately. **Damage done by over-firing is not covered by your warranty.** Results of over-firing can include: warped or burned out internal parts, cracked stones, discolored or warped external parts, and damaged enamel.

**NOTE: ANY SYMPTOMS OF OVER-FIRING WILL VOID YOUR WARRANTY!!**

## REMOVAL AND DISPOSAL OF ASHES

Ashes should be removed when the stove is cold. Use protective fireplace gloves when the pan is warm. Exercise extreme caution when handling, storing or disposing of ashes.

The ash pan and ash pan access door is located under the ash lip. The ash pan collects burned ash from a fire and allows you to conveniently remove the ash from your wood stove. The firebox should be cleared of ashes daily by sliding the ash grate sideways, sifting the ashes across the grate into the ash pan, then returning the grate to its closed position. The ash pan is easy to remove and has a handle for convenient disposal of ashes. The back of the ash pan assembly is sloped upwards. Before removing the ash pan, push it (hard!) into the stove to force the pan up the slope, which kicks the ashes further into the pan.

Ashes should be dumped from the ash drawer into a metal container with a tight fitting lid. Do not place any other items or trash into the metal container. Replace the lid onto the container and allow the ashes to cool. Do not place the ash disposal container on a combustible surface or vinyl flooring, as the container will be **hot!**

Pending disposal, place the closed ash container on a noncombustible floor or on the ground, well away from all combustible materials. Ashes should be retained in the closed container until all cinders have thoroughly cooled.

Ashes should NEVER be placed in wooden or plastic containers, or in paper or plastic bags, no matter how long the fire has been out. Coals within a bed of ashes can remain hot for several days once removed from the firebox.

## MAINTENANCE

### MONITORING STOVE TEMPERATURES

Monitor the stove temperatures with a stove thermometer (available from your dealer) placed on the top center stone of the stove. The thermometer could read as high as 500°F(260°C) on High Burn and 200-300°F(93-149°C) on low burn. Maintaining temperatures in excess of 600°F(316°C) will cause the stones to crack and other damage to the stove.

**Do not over-fire the stove.** (refer to page 17).

**Damage done by over-firing will void the warranty.**

## CREOSOTE FORMATION AND NEED FOR REMOVAL

When wood is burned slowly, it produces tar and other organic vapors, which combine with expelled moisture to form creosote. These creosote vapors condense in the relatively cool chimney flue of a slow-burning fire. As a result, creosote residue accumulates on the flue lining. When ignited, this creosote makes an extremely hot fire, which may damage the chimney or even destroy the house. When burning wood, the chimney connector and chimney should be inspected at least once every two months during the heating season to determine if a creosote buildup has occurred.

To prevent the buildup of creosote:

1. Burn the stove with the primary air control fully open for 35 - 45 minutes daily to burn out creosote deposits from within the stove and the venting system.
2. After reloading with wood, burn the stove with the primary air control fully open for 20 to 30 minutes. This manner of operation ensures early engagement of the secondary combustion system which, when engaged, minimizes creosote buildup in the chimney.

The stovepipe connector and chimney should be inspected at least monthly during the heating season to determine if a creosote build-up has occurred. If a creosote residue greater than 1/4" (6 mm) has accumulated, it should be removed to reduce the risk of a chimney fire.

If your glass is remaining dirty, your operating temperatures are low; therefore, there is a higher risk of creosote buildup.

The venting system must be inspected at the stove connection *and* at the chimney top. Cooler surfaces tend to build creosote deposits quicker, so it is important to check the chimney at the top (where it is coolest) as well as from the bottom near the stove.

Accumulated creosote should be removed with a cleaning brush specifically designed for the type of chimney in use. A certified chimney sweep should be used to perform this service. Contact your dealer for the name of a certified chimney sweep in your area (your dealer may be a certified sweep!).

It is also recommended that before each heating season the entire system be professionally inspected, cleaned and repaired, if necessary.

## GASKETS

Gasket material should normally be replaced every two to three seasons, depending on stove use. If the door seal is loose, a new gasket will assure a tight seal and improved stove performance. Contact your dealer for a gasket kit that includes instructions and gaskets for your stove.

The procedure for replacing gaskets on the glass is reviewed on page 18 – Glass.

To replace door gaskets, first remove the old gaskets with a utility or putty knife. Clean all gasket channels with a wire brush. Apply gasket cement to the channels and push the new gasket into place without stretching the gasket material. The door should be shut immediately to fully press the gasket into place and assure a positive seal.

We require the use of the following gaskets:

GLASS: 42" (107 cm) Length, 3/4" (5 cm) Wide, Adhesive Backed Black Tape

FRONT DOOR: 54" (137 cm) Length, 1/4" (.64 cm) Diameter, Low Density Black Tube

ASH DOOR: 22.5" (57 cm) Length, 3/8" (9.5 mm) Diameter, Low Density, Black Tube

SIDE DOOR: 42" (107 cm) Length, 1/2" (1.3 cm) Diameter, Low Density, Black Tube

## GLASS

Do not operate the stove with a broken door glass. Do not abuse the front door by striking or slamming.

When necessary, the glass can be cleaned with low alkaline content commercial stove glass cleaners, which are available from your local dealer. Never attempt to clean the glass while the fire is burning or the glass is hot. Most deposits can be cleaned by following the instructions provided with the cleaner. To clean heavier deposits, open the door and lift it straight up and off the stove with the hinge pins remaining in the door (take care to save hinge pins and washers for reuse). Lay the door face down on a workbench or table. Apply the cleaner to the glass and allow it to set for a few minutes. By laying the door flat, it will allow the cleaner to penetrate rather than running off the surface of the glass. Wipe the cleaner off with a soft cloth.

**Important:** scratching or etching the glass will weaken the integrity of the glass. Do not use a

razor blade, steel wool, or any other abrasive material to clean the glass. Use low alkaline content cleaners only.

The front door glass is a ceramic, shock-resistant glass, made specifically for use in woodstoves. Do not use any replacement glass other than the ceramic glass manufactured and supplied for use in this woodstove. Replacement glass is available through your local dealer.

The door glass should be replaced immediately if broken. Contact your local dealer for replacement glass, which is accompanied with instructions and everything needed for the repair. If you replace the glass yourself, wear work gloves and safety glasses.

The procedure for glass and glass gasket replacement is as follows:

1. Remove the door by lifting it straight up off the hinges with the hinge pins remaining in the door.
2. Place the door face down on a flat, smooth surface.
3. Apply penetrating oil to the screws in the glass retainer clips. Remove the screws to separate the glass from the door.
4. Carefully lift the damaged glass from the door and discard.
5. Peel the paper backing from the tape gasket. Apply the new gasket to the new glass as illustrated on page 17.

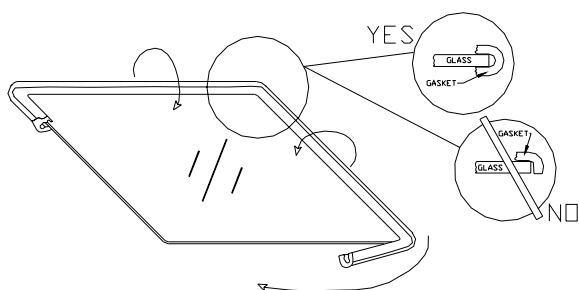

6. Place the gasketed glass onto the door.
7. Screw the glass retainer clips back on the door.
8. Install the door.

## STONE

Occasional cleaning is all that should be necessary to maintain the natural beauty of your stove's polished soapstone finish. Clean the soapstone with water, any non-abrasive cleaner and a soft cloth. Wipe dust from the stone with a clean cloth. Do not use chemical agents to wash the stone; do not use waxes or any polishing agents on the stone.

Care must be taken not to scratch or chip the stone. Do not set items, which can scratch or chip the stone (or enamel finish), on top of your stove.

Often, with use and over time, subtle earth tones of brown, red, and yellow appear on the soapstone. This is a natural reaction in the soapstone. Surface or hairline fractures may appear in the stone after a stove has been used. Such changes are normal and do not affect the operation or the integrity of the stove and do not require replacement. If you observe a completely broken stone, contact your dealer for service.

## CAST IRON

Exterior cast iron parts are either painted with black, high-temperature stove paint or porcelainized with an enamel finish in various colors.

Use black, high-temperature stove paint (satin black by Stovebright) to touch up and maintain the original appearance of painted cast iron. Use a damp sponge to wipe clean. Dry the cast iron thoroughly to prevent rusting.

Enamel castings can be cleaned with a standard glass cleaner. With time and use, a very fine, subtle network of crazed lines may appear seemingly beneath the surface of the enamel. Crazing is a natural predictable process and does not represent a flaw.

## TROUBLESHOOTING

### Your Heating Needs

Virtually all woodstove operators experience basic common problems at one time or another. Most are correctable and generally require only a minor adjustment of the stove, installation, or operating technique. In cases where weather conditions dramatically affect stove performance, the problems are typically temporary and solve themselves once the weather changes.

If you question whether your stove is producing adequate heat, the best way to troubleshoot the problem is to monitor the temperature of the stack. A 400 degree F (200 degree C) stovepipe confirms the stove is supplying sufficient heat. Keep in mind that your house itself will regulate room/house temperatures. How well the walls, floors and ceilings are insulated, the number and size of glass windows, the tightness of outside doors, and the construction or style of your house (vaulted ceilings or other open spaces which collect large percentages of heat,

ceiling fans, etc.) all are determining factors of room temperature.

Your stove's performance is also dependant on its installation. One common cause of poor performance is an oversized chimney flue. Oversized chimney flues result in decreased pressure, which prevents the smoke from rising out the chimney. Oversized flues are also more difficult to heat effectively, especially when burning a high efficiency stove. Cool flue temperatures inhibit the establishment of a strong draft (and encourage the accumulation of creosote). The lack of a strong draft will cause the fire to die down and may even force the smoke to pour into the room.

If your chimney is the proper size and a strong draft is not easily established, there is the possibility of the chimney being too cold. Again, hot chimneys promote a stronger draft.

Other draft guidelines are as follows:

**AN "AIRTIGHT" HOUSE:** If your home is super-insulated or especially well sealed, the (infiltration) air supply to the interior of the house may be inadequate. This phenomenon of air starvation within the building can be exacerbated if exhaust fans, such as clothes dryers, bathroom fans or cookstove exhaust fans, are in operation within the home. Outfitting your stove with the optional outside air supply adaptor connected to an air duct which leads to the outside of the building should correct this problem.

**TALL TREES OR BUILDINGS:** These obstructions, when located in proximity to the top of the chimney can cause chronic or occasional downdrafts. When selecting a site for a new chimney, take care to consider the placement of other objects near the proposed chimney location.

**WIND VELOCITY:** Generally, the stronger and steadier a wind, the stronger (better) the draft. However, "gusty" wind conditions may cause erratic downdrafts.

**BAROMETRIC PRESSURE:** Chimney drafts are typically sluggish on balmy, wet or muggy days. This is a weather-related phenomenon, which generally is self-correcting as the weather changes.

**BRISKNESS OF FIRE:** The hotter the fire in your stove, the hotter your chimney and, therefore, the stronger the draft.

**BREAKS IN THE VENTING SYSTEM:** An unsealed clean-out door at the bottom of the chimney, leaky

stovepipe joints, a poor stovepipe-to-thimble connection, or a leaky chimney may cause inadequate draft.

**SEASONAL FACTORS:** Early fall and late spring are generally difficult seasons in which to establish proper drafts. The colder the outside air is (relative to room temperatures) the stronger the draft.

### **Operating the Stove**

There are days when a draft is not easily established. As outlined above, seasonal factors or a cold chimney may be the cause. Try starting the fire by using small kindling and fuel to obtain a quick, hot fire. Tend the fire frequently with small fuel until the chimney is hot and the draft is well established.

## TROUBLESHOOTING GUIDE

<b>PROBLEM</b>	<b>POSSIBLE CAUSE</b>	<b>SOLUTIONS</b>
STOVE SMOKES	Operating Technique Cold Chimney Blocked Chimney	Fully open the primary air control one minute before opening doors. Preheat the chimney when first starting a fire. Examine the chimney and stovepipe for blockage or creosote accumulations.
	Oversized Chimney Undersized Chimney Chimney Too Short Air Infiltration Into The Chimney More Than One Appliance Connected to the Flue	Reline the chimney to the appropriate diameter Install a draft inducer or replace the chimney. Lengthen the chimney. Seal chimney connections and openings in clean-out doors. Disconnect all other appliances and seal openings.
BACK-PUFFING OR GAS EXPLOSIONS	Operating Technique	Fully open the primary air control one minute before opening the door and keep it fully open for a few minutes after reloading.
	Extra Low Burn Rate Chimney Down-draft Excessive Ash Build-up	Burn the stove at a higher burn rate. Install a chimney cap. Empty ash pan more frequently.
UNCONTROLLED OR SHORT BURN	Unsealed or Open Door Open ash grate Excessive Draft	Close the door tightly or replace the gaskets. Slide ash grate to closed position. Check the installation. Operate at LOW BURN. Install stovepipe damper.
	Deteriorated Cement Seals Extra Long Chimney Oversized Chimney High Winds or Hilltop Location: Excessive Draft	Reseal the stove with furnace cement. Shorten the chimney. Install stovepipe damper. Reline the chimney to the proper diameter. Install a chimney cap. Draft in excess of 0.1 wc should be corrected with a stovepipe damper
INSUFFICIENT HEAT	Poor Quality or Green Wood Low Burn Rate Air Insulated Chimney	Use only air-dried wood, preferably dried <u>at least</u> one year. Operate the stove at a higher burn rate. Replace with a pre-fabricated insulated chimney system or a properly sized masonry chimney.
	Cold Exterior Chimney Leaky Stovepipe or Chimney Too Much Heat Loss From House	Reline or insulate the chimney. Check the installation. Caulk windows, seal openings in home.
BLISTERING OF ENAMEL CASTING	Operating Technique	Do not over-fire the stove. Monitor stove temperatures. Use seasoned wood only.
	Excessive Draft	Check the DRAFT. A damper may be required. Operate the stove at a LOW BURN range.

## REPLACEMENT PARTS & OPTIONAL ACCESSORIES

<b>PART NUMBER:</b>	<b>DESCRIPTION:</b>	<b>PART NUMBER:</b>	<b>DESCRIPTION:</b>
<b>CASTINGS:</b>		1421-55	SOAPSTONE 2-3/4 X 6-11/16
2421-341	ANDIRON	1421-56	SOAPSTONE 6-11/16 X 9-1/2
2510-303	BOTTOM LEG	1201-25	SOAPSTONE 6 X 9-1/2
2010-110	BOTTOM	1421-54	SOAPSTONE 4 X 6-11/16
2010-300	SIDE LEG (CORNER POST)	<b>FIREBRICK:</b>	
2010-810	TOP	3060-430	4-1/2 X 9 X 1-1/4
2010-500	FRONT DOOR	3060-427	1-15/16 X 9 X 1-1/4
2010-600	FRONT DOOR OUTER FRAME	<b>MISC:</b>	
2010-550	GLASS RETENTION FRAME	5400-2202	SIDE DOOR LATCH
2010-200	ASH LIP	5010-055	ASH DOOR LATCH
2010-060	ASH DOOR	5010-080	CHROME HANDLES (CRANKS)
2010-050	ASH DOOR FRAME	3900-177	WOODEN HANDLE
2010-510	SIDE DOOR	3030-026	FRONT DOOR GLASS
2010-610	SIDE DOOR OUTER FRAME	5600-024	DURA BLANKET
2010-900	FLUE COLLAR	3060-XXX	CERAMIC BOARD (SIDE DOOR)
2610-017	GRATE FRAME	3120-XXX	13" X 21" X 1" CERAMIC BLANKET
2610-018	GRATE	5400-2206	FRONT DOOR LATCH
2010-612	SIDE DOOR INNER FRAME	3120-210	CERAMIC BLANKET
2010-422	SIDE PLATE (RIGHT SIDE)	<b>STEEL PARTS:</b>	
<b>SOAPSTONE:</b>		5012-202	PRIMARY AIR PLENUM
1421-57	SOAPSTONE 8-1/32 X 9-1/2	5012-102	SECONDARY AIR PLENUM
1421-58	SOAPSTONE 8-1/32 X 15-5/8	5012-222	SECONDARY AIR TUBE RISER
1141-251	SOAPSTONE 2-3/4 X 9-1/2	5012-261	SECONDARY AIR TUBE-#1 REAR
1141-252	SOAPSTONE 4 X 9-1/2	5012-262	SECONDARY AIR TUBE-#2 MIDDLE
1141-254	SOAPSTONE 2-2-3/4 X 9-1/2	5012-263	SECONDARY AIR TUBE-#3 FRONT
1201-26	SOAPSTONE 4 X 9-1/2	5600-050	SIDE DOOR WEAR PLATE
<b>OPTIONAL ACCESSORIES:</b>		5210-2325	THREADED RODS 3/8"-16 X 22"
90-57500	OUTSIDE AIR ADAPTER	5012-052	PRIMARY AIR INLET/ASH PAN
5930-2000	REAR HEAT SHIELD	5012-056	PRIMARY AIR CONTROL SLIDER
90-57000	BLOWER		

**SAFETY LABEL**

**CONTACT YOUR LOCAL BUILDING AND INSTALLATION**

**OFFICIALS ABOUT RESTRICTIONS INSPECTION IN YOUR AREA**

Listed Room Heater, Solid Fuel Type  
Also Suitable for Mobile Home Installation Pursuant to (UM)84-HUD



Intertek Testing Services NA, Inc.

Manufactured by:  
NHC, INC.  
P.O. Box 1069  
Morrisville, VT 05661

**"PREVENT HOUSE FIRES"**

Install in accordance with manufacturer's installation instructions and your local building codes.

**CAUTION:** Special methods are required when passing chimney through a wall or ceiling, refer to installation instructions or local building codes. Do not connect this unit to a chimney flue serving another appliance.

**NOTE:** Replace glass only with 5mm CERAMIC IR or NEOCERAM IR glass.

**WARNING: (MOBILE HOME)** An outside air inlet must be provided for combustion, and be unrestricted while unit is in use.

SERIAL NO.

**MODEL NAME:** HERITAGE

**TESTED TO:** UL 1482, ULC S627

**TYPE OF FUEL:** Solid Wood Only

**WARNINGS:**

Do not operate with doors open.

Do not obstruct space under heater.

Do not use grate or elevate fire - build wood fire directly on hearth.

Do not overfire. If heater or chimney connector glows, you are overfiring.

**Minimum Clearances to Combustible Materials (in inches)\***

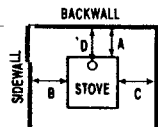

- A - 25" (635 mm)
- B - 20" (508 mm)
- C - 16" (406.4 mm)
- D - 27" (685.8 mm)

When installed on a combustible floor, non-combustible floor protection is required to cover the area beneath the heater, and extend at least 18" to the front and 8" to the sides of the fuel opening.

\* Refer to Installation Manual for additional clearance information.

**VENT REQUIREMENTS:**

6 inch diameter, single wall, minimum 24 MSG black or 25 MSG blue steel connector with listed factory-built Type HT chimney or masonry chimney.

**OPTIONAL COMPONENTS:**

- Rear Heat Shield Part #90-57200
- Outside Air Kit Part #90-57600
- Blower Part #90-57000



**CAUTION:**

**HOT WHILE IN OPERATION. DO NOT TOUCH. KEEP CHILDREN, CLOTHING AND FURNITURE AWAY. CONTACT MAY CAUSE SKIN BURNS. SEE NAMEPLATE AND INSTRUCTIONS. INSPECT AND CLEAN CHIMNEY AND CONNECTOR FREQUENTLY. UNDER CERTAIN CONDITIONS OF USE, CREOSOTE BUILDUP MAY OCCUR RAPIDLY.**

**TYPE OF FUEL: SOLID WOOD ONLY**

**U.S. ENVIRONMENTAL PROTECTION AGENCY**  
Certified to comply with July, 1990 particulate emission standards.

**Date of Manufacture**

1997 1998 1999 Jan. Feb. Mar. Apr. May June July Aug. Sept. Oct. Nov. Dec.

**DO NOT REMOVE THIS LABEL**

**Made in U.S.A.**

**3300-624**



# HEARTHSTONE WOODSTOVE LIMITED WARRANTIES

**These warranties give you specific legal rights. You may also have other rights which vary from State to State.** HearthStone Quality Home Heating Products, Inc. (HearthStone) warrants **to the original purchaser only** (the “Original Purchaser”) the new woodstove manufactured by HearthStone and purchased by the Original Purchaser (the “Woodstove”) against any of the occurrences listed in this document that result from defects in material or workmanship. All obligations of HearthStone under this document commence on the date the Original Purchaser purchases the Woodstove (the “Purchase Date”).

## **LIMITED LIFETIME WARRANTY**

HearthStone warrants the following parts of the Woodstove against the following occurrences that result from defects in material and workmanship:

- All cast iron parts – against breakage, cracking or burn-through.
- All stones – against cracking or breakage due to thermal stress, **excluding** surface and hairline cracks and scratches that do not affect the operation or safety of the Woodstove.
- Primary and secondary air supply systems, including riser tubes, air wash system, secondary air manifold and stainless steel secondary air supply tubes – against breakage, cracking or burn-through.
- Glass – against breakage due to thermal shock.

## **LIMITED FIVE-YEAR WARRANTY**

HearthStone warrants the following parts of the Woodstove against the following occurrences that result from defects in material and workmanship:

- Refractory brick – against breakage and deterioration ***not*** resulting from physical damage or over-loading of the Woodstove.
- Firebox baffle (the baffle above the secondary air tubes) – against breakage, cracking or burn-through.
- Door handles and latch mechanisms – against breakage.

**This warranty expires on the fifth (5<sup>th</sup>) anniversary of the Purchase Date.**

## **LIMITED ONE-YEAR WARRANTY**

HearthStone warrants the following parts of the Woodstove against the following occurrences that result from defects in material and workmanship:

- Enamel Finish – against peeling or fading, **excluding** chipping, mechanical abrasion, chemical abrasion or crazing.
- Stove cement and all gaskets – against breakage or deterioration.
- Accessories and electrical components such as blowers, switches and thermo discs, **excluding** venting components, hearth components, electrical components and other components or accessories used in conjunction with the installation of the Woodstove ***not*** manufactured or supplied by HearthStone – against breakage or malfunction.

**This warranty expires on the first (1<sup>st</sup>) anniversary of the Purchase Date.**

## **EXCLUSIONS**

The warranties contained in this document do not cover, nor is HearthStone responsible for:

1. Damage resulting from installation or operation of the Woodstove in a manner contrary to the owner’s manual.
2. Damage to the Woodstove or cracking of stones due to improper break-in firing procedures.
3. Damage or non-performance resulting from faulty or incomplete setup, installation and start-up or mishandling, abuse, or misuse of the Woodstove, including but not limited to over-firing.
4. Damage resulting from installation, modification, alteration, repair or service of the Woodstove by any party other than HearthStone or an authorized HearthStone dealer (a “Dealer”).
5. Damage resulting from the use as fuel of driftwood, treated wood, wax, artificial or manufactured logs, coal or other material other than natural wood.

6. Damage due to water or due to installation of the Woodstove in a damp or high condensation area.
7. Damage due to installation of the Woodstove in an atmosphere contaminated by damaging chemicals, including but not limited to chlorine, fluorine or salts.
8. Scratches on glass, enameled surfaces or stones due to mechanical abrasion.
9. Standard wear and tear of the Woodstove resulting from normal usage over time.
10. Damage resulting from operational-related problems such as over-firing, downdrafts, smoke spillage, or use of corrosive driftwood.
11. Damage or inadequate performance caused by site, installation or environmental conditions beyond HearthStone's control, including but not limited to nearby trees, rooftops, buildings, wind, hills, mountains, inadequate or excessive venting, insufficient make up air, or negative air pressure whether or not caused by mechanical systems such as furnaces, exhaust fans, clothes dryers, etc.
12. A defect in any part of the Woodstove if the Original Purchaser fails to comply with HearthStone's or a Dealer's request to ship the part or the Woodstove to HearthStone or a Dealer, as the case may be.

THE WARRANTIES CONTAINED IN THIS DOCUMENT ARE EXCLUSIVE AND ARE GIVEN BY HEARTHSTONE AND ACCEPTED BY THE ORIGINAL PURCHASER IN LIEU OF ALL OTHER EXPRESS WARRANTIES AND ANY OBLIGATIONS, LIABILITIES, RIGHTS, CLAIMS, OR REMEDIES IN CONTRACT OR TORT, WHETHER OR NOT ARISING FROM HEARTHSTONE'S NEGLIGENCE, ACTUAL OR IMPUTED. ALL IMPLIED WARRANTIES, INCLUDING THE WARRANTIES OF MERCHANTABILITY AND FITNESS FOR A PARTICULAR PURPOSE, ARE GIVEN **ONLY** TO THE EXTENT REQUIRED BY FEDERAL OR STATE LAW. EXCEPT AS OTHERWISE REQUIRED BY STATE LAW, UPON THE EXPIRATION OF THE EXPRESS LIMITED WARRANTIES CONTAINED HEREIN, **NO** IMPLIED WARRANTIES, INCLUDING THE IMPLIED WARRANTIES OF MERCHANTABILITY OR FITNESS FOR A PARTICULAR PURPOSE, SHALL APPLY TO THE SUBJECT WOODSTOVE. **SOME STATES DO NOT ALLOW LIMITATIONS ON HOW LONG AN IMPLIED WARRANTY LASTS, SO THE ABOVE LIMITATION MAY NOT APPLY TO YOU.**

THE WARRANTIES CONTAINED IN THIS DOCUMENT EXTEND **ONLY** TO THE ORIGINAL PURCHASER OF THE WOODSTOVE WARRANTED HEREUNDER. THEY DO NOT EXTEND TO ANY SUBSEQUENT OWNERS.

UNDER NO CIRCUMSTANCES SHALL HEARTHSTONE BE LIABLE TO THE ORIGINAL PURCHASER OR ANY OTHER PERSON FOR ANY INCIDENTAL OR CONSEQUENTIAL DAMAGES, INCLUDING BUT NOT LIMITED TO DAMAGE TO PROPERTY OR PERSONAL INJURIES, WHETHER ARISING OUT OF BREACH OF WARRANTY, TORT, OR OTHERWISE, EVEN IF HEARTHSTONE HAS BEEN APPRAISED OF THE POSSIBILITY OF SUCH DAMAGES. **SOME STATES DO NOT ALLOW THE EXCLUSION OR LIMITATION OF INCIDENTAL OR CONSEQUENTIAL DAMAGES, SO THE ABOVE LIMITATION OR EXCLUSION MAY NOT APPLY TO YOU.**

#### **QUALIFYING FOR WARRANTY COVERAGE**

To obtain performance of any obligation under this document, the Original Purchaser must, **within the applicable warranty time period**, contact HearthStone, at the address listed in the Warranty Registration section below or at **(802) 888-5235**, or a Dealer for instructions regarding the return of defective parts for repair, the return of the Woodstove for repair, or a Dealer service call. The Original Purchaser should refer to the Dealer network search engine contained on HearthStone's Web site ([www.hearthstonestoves.com](http://www.hearthstonestoves.com)), or call HearthStone at (802) 888-5235, to find a Dealer nearest the Original Purchaser's location.

#### **REMEDY**

The remedy for any breach of the foregoing warranties will consist of repair or replacement, at HearthStone's option, of any covered defect in the Woodstove. When the Original Purchaser contacts HearthStone or a Dealer, HearthStone or the Dealer, as the case may be, will instruct the Original Purchaser to **either** return the defective part, or the entire Woodstove (if needed), with shipping prepaid, to HearthStone or a Dealer **or** allow a Dealer to

make a service call at the place where the Woodstove is located. In the event the Original Purchaser refuses to allow a Dealer to make a service call, HearthStone or a Dealer, as the case may be, will request that the Original Owner return the defective part, or the entire Woodstove (if needed), with shipping prepaid, to HearthStone or a Dealer. **Notwithstanding any other provision of this document, the Original Purchaser shall pay for any travel fees and service charges related to a Dealer's service call.**

**Parts:** HearthStone will replace defective parts covered by the foregoing warranties at no charge.

**Labor:** Within the first (1<sup>st</sup>) year after the Purchase Date, HearthStone will pay for warranty labor performed by a Dealer at HearthStone's published labor rates in effect at the time the labor is performed. Thereafter, the Original Purchaser is responsible for the cost of labor.

**Shipping cost for parts:** Within the first ninety (90) days after the Purchase Date, HearthStone will pay for the shipping of Woodstove parts covered by any of the foregoing warranties to and from HearthStone or a Dealer, as the case may be. Thereafter, the Original Purchaser is responsible for all shipping costs related to shipping Woodstove parts to and from HearthStone or a Dealer, as the case may be.

**Shipping cost for the Woodstove:** Within the first (1<sup>st</sup>) year after the Purchase Date, if the Original Purchaser is instructed to return the Woodstove to HearthStone or a Dealer for repair, HearthStone will pay fifty percent (50%) and the Original Purchaser will pay fifty percent (50%) of the shipping costs related to shipping the Woodstove to and from HearthStone or a Dealer, as the case may be. Thereafter, the Original Purchaser is responsible for one hundred percent (100%) of all of the shipping costs related to shipping the Woodstove to and from HearthStone or a Dealer, as the case may be. Notwithstanding any other provision of this document, in no event will HearthStone pay for any Dealer fees or other fees for pick up or delivery of the Woodstove returned for repair; the Original Purchaser shall be responsible for any such fees.

#### **WARRANTY REGISTRATION**

The Original Purchaser may send a completed and signed Warranty Registration Form, which is enclosed in the Woodstove warranty packet, to the following address:

HearthStone Quality Home Heating Products, Inc.  
Warranty Department  
317 Stafford Avenue  
Morrisville, VT 05661

**NOTE: SENDING IN THE SIGNED WARRANTY REGISTRATION FORM IS *NOT* A CONDITION OF WARRANTY COVERAGE OR HEARTHSTONE'S PERFORMANCE.**

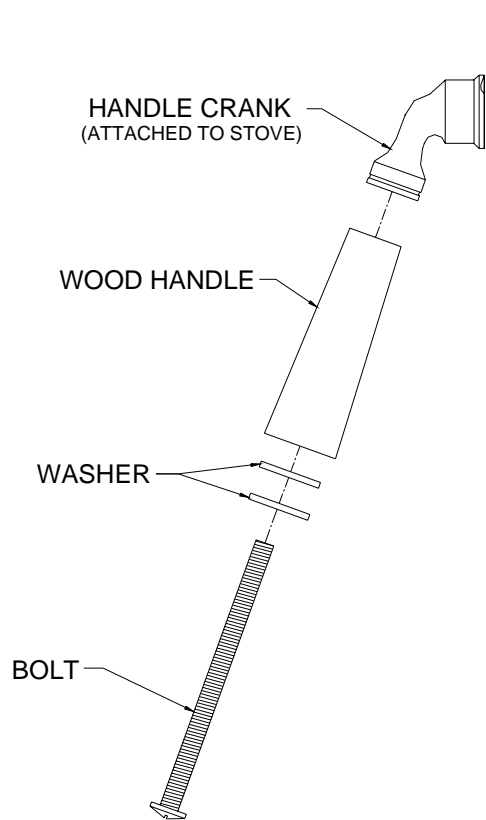

## HANDLE ASSEMBLY

Locate the handle, bolt, and washers enclosed in the envelope with the owner's manual. Place the washers on the bolt and then push it through the handle so that the bolt threads extend through the bottom of the handle. Using a slotted screwdriver, turn the bolt into the chrome latch on the door, until snug.

## HANDLE OPERATION

Front Door – when closed, the handle will be in the 8 o'clock position. To open the front door, rotate the latch clockwise to approximately the 10 o'clock position.

Ash Pan Door – when closed, the handle will be in the 6 o'clock position. To open the ash door, rotate the latch counter-clockwise to approximately the 3 o'clock position.

Side Door – when closed, the handle will be in the 5 o'clock position. To open the side door, rotate the latch counter-clockwise, to approximately the 2 o'clock position.

**Notes:**